

Overview

HP 3PAR StoreServ 7000 Storage

HP 3PAR StoreServ 7000 Storage offers enterprise Tier 1 storage at a midrange price. Spend less time managing storage, get more features for less money, and do it all without sacrificing performance or future scalability. HP 3PAR StoreServ 7000 Storage provides high performance and guarantees to double your virtual machine density. With hardware assisted thin storage it is the only platform that guarantees a 50% reduction in capacity requirements. HP 3PAR StoreServ is also the first product family with a common architecture capable of six nines availability that meets SMB needs and spans to the largest global enterprise giving you access to the same features as the world's largest service providers. You can start small and grow without painful upgrades down the road.

HP 3PAR StoreServ 7000 is storage made effortless.

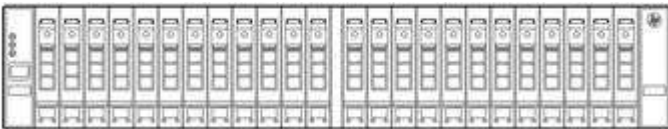

HP 3PAR StoreServ 7200c

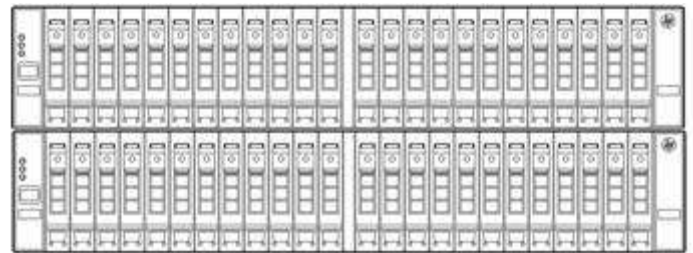

HP 3PAR StoreServ 7400c Storage

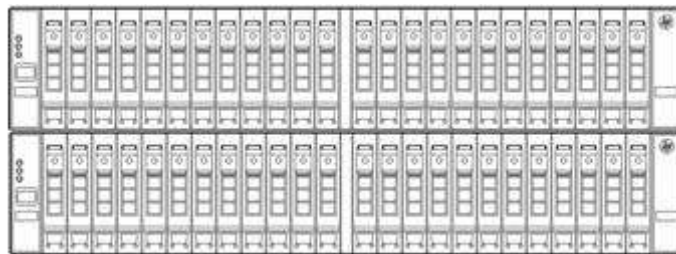

HP 3PAR StoreServ 7440c Storage

What's New

- HP 3PAR File Persona Software Suite for HP 3PAR StoreServ 7200c/7400c/7440c
- New HP 3PAR StoreServ 7440c Storage system with support for 960 drives
- HP 3PAR StoreServ 7200c All-Flash Starter Kit provides all-flash acceleration at entry-level price
- New HP 3PAR 2-port 16Gb/sec Fibre Channel Adapter
- New HP 3PAR 2-port 10Gb and 4-port 1Gb Ethernet Adapters
- New lower cost 480 GB and 1.92 TB cMLC SSDs available
- New FIPS 140-2 compliant encryption with enterprise key management for high-availability data protection
- Support for Adaptive Flash Cache that helps reduce application response times for read intensive workloads
- Accelerate writes with HP 3PAR Express Writes
- HP 3PAR StoreServ 7200 and StoreServ 7400 Storage Systems are now ENERGY STAR certified

Overview

NOTE: The term “HP 3PAR StoreServ 7000 Storage” refers to the whole 7000 family, including both the new 7000c platforms (7200c, 7400c, and 7440c) as well as the older 7000 platforms (7200 and 7400).

Summary	3PAR StoreServ 7200c	3PAR StoreServ 7400c	3PAR StoreServ 7440c	3PAR StoreServ File Controller v2
Number of Controller Nodes	2	2 or 4	2 or 4	Up to 8
HP 3PAR Gen4 ASICs	2	2 or 4	2 or 4	Not Applicable
Processors	2 six-core 1.8 GHz	2-4 six-core 1.8 GHz	2-4 eight-core 2.3 GHz	1-16 four-core 2.4 GHz
Total Cache	808 GB	1596 GB	3192 GB	Not Applicable
Flash Cache (optional)	768 GB	1500 GB	3000 GB	Not Applicable
On-Node Cache	40 GB	96 GB	192 GB	None
Total Cache per controller node pair	808 GB	816 GB	1596 GB	Not Applicable
Flash Cache per node pair	768 GB	768 GB	1500 GB	Not Applicable
On-Node Cache per node pair	40 GB	48 GB	96 GB	None
Maximum Host Ports	12 ports	24 ports	24 ports	4 – 128
8Gb/s Fibre Channel Host Ports	4 - 12 ports	4 - 24 ports	4 - 24 ports	Not Applicable
16Gb/s Fibre Channel Host Ports	0 - 4 ports	0 - 8 ports	0 - 8 ports	Not Applicable
10Gb/s iSCSI Host Ports	0 - 4 ports	0 - 8 ports	0 - 8 ports	Not Applicable
10Gb/s Ethernet Adapter	0 - 4 ports	0 - 8 ports	0 - 8 ports	Not Applicable
1Gb/s Ethernet Adapter	0 - 8 ports	0 - 16 ports	0 - 16 ports	Not Applicable
1GbE/10GbE Network Ports	Not Applicable	Not Applicable	Not Applicable	4 – 128
Maximum Initiators Supported	1024	1024 or 2048	1024 or 2048	Not Applicable
2U Controller Enclosure SAS Drive Capacity	24	24	24	Not Applicable
Number of Disk Drives	8 – 240 ¹	8 – 576	8 – 960	2 (per node)
Number of Solid State Drives	8 – 120 ¹	8 – 240	8 – 240	None
Raw Capacity (approx.) ²	1.2 – 500 TB	1.2 – 1600 TB	1.2 – 2000 TB	Not Applicable
Usable File Capacity	2 - 64TB ⁹	2 - 128TB ⁹	2-128TB ⁹	Depends on the usable capacity from the 3PAR array

Capacity Details	3PAR StoreServ 7200c	3PAR StoreServ 7400c	3PAR StoreServ 7440c	3PAR StoreServ File Controller v2
RAID Levels	RAID 0, 1, 5, 6			RAID 0, 1, 5, 6 ⁷
RAID 5 Data to Parity Ratios	2:1 - 8:1			2:1 - 8:1 ⁷
RAID 6 Data to Parity Ratios	4:2, 6:2, 8:2, 10:2, 14:2			4:2, 6:2, 8:2, 10:2, 14:2 ⁷
Drive Capacities (approximate GB ³) (RAID levels, parity ratios, and drive capacities all mixable within the same Storage System)	200 SSD ⁴ , , 480 SSD ⁴ , 920 SSD ⁴ , 480GB cMLC SSD, 1.92TB cMLC SSD, 300 15K SAS, 450 10K SAS, 600 10K SAS, 900 10K SAS, 1200 10K SAS, 1000 7.2K NL, 2000 7.2K NL ⁵ , 3000 7.2K NL ⁵ , 4000 7.2K NL ⁵			Not Applicable

Overview

Number of Add-on Drive Enclosures (Each Drive Enclosure holds up to 24 drives in 2U for small form factor drives and 4U for large form factor drives)	0 - 9 enclosures	0 - 22 enclosures	0 - 38 enclosures	Not Applicable
--	------------------	-------------------	-------------------	----------------

¹ The minimum drive quantity is permitted as long as the total raw capacity is at least 1.2 TB.

² Maximum raw capacity currently supported with any and all drive types.

³ For storage capacity, 1 GB = 1,000,000,000 bytes and 1 TB = 1,000 GB.

⁴ SSDs are Solid State Drives.

⁵ NL drives are 7200 RPM Enterprise SAS drives.

⁷ Applies to the array storage assigned to 3PAR StoreServ File Controller for file services

⁸ For details, please refer to the 3PAR StoreServ File Controller v2 section in this document.

⁹ Usable file capacity supported for HP 3PAR File Persona Software Suite.

NOTE: Specifications are subject to change without notice.

Host OS Support

Citrix® XenServer® | HP-UX® | IBM® AIX®

Microsoft® Windows® Server, including Microsoft® Hyper-V™

Open VMS | Oracle® Linux® (UEK and RHEL compatible kernels) | Oracle® Solaris

Red Hat® Enterprise Linux® | Red Hat® Enterprise Virtualization

SUSE® Linux Enterprise | Ubuntu | VMware vSphere™

For the latest information on supported operating systems refer to Single Point of Connectivity Knowledge for HP Storage Products (SPOCK): <http://www.hp.com/storage/spock>

Standard Features

Efficient

Get thin and stay thin - Thin technologies unique to the HP 3PAR StoreServ family can reduce capacity requirements by 50%. Purchase only what you need, as you need it so you can focus resources on growing your business, not maintaining your storage. Additionally, the HP 3PAR ASIC with Thin Built In features an efficient, silicon-based zero-detection mechanism. This unique hardware capability gives HP 3PAR StoreServ Storage the power to remove allocated but unused space without impacting performance.

Data center virtualization - Increase virtualization return on investment. Double virtual machine density on your physical servers, spend up to 90 percent less time managing your storage, and support your virtualization deployment with 50 percent less storage capacity. HP 3PAR StoreServ is built from the ground up to deliver performance that exceeds the demands of virtualized data centers along with transformative levels of simplicity, agility, and efficiency.

Service levels - With policy-based autonomic sub-LUN tiering, you can balance the cost of capacity and the cost of performance and put the right data on the right storage tier at the right time.

Do more with less - With HP 3PAR StoreServ Storage you can purchase up to 75 percent less capacity-meaning less equipment to house, fewer disks to power and cool, less hardware to retire after it has reached its end of life, and a reduced carbon footprint.

HP 3PAR Express Writes - HP 3PAR Express Writes is a write acceleration feature built in to HP 3PAR OS version 3.2.1 and later to optimize CPU utilization and, depending on workload, deliver greater throughput, up to 30 percent more IOPS, and 20 percent reduced latency¹. All currently supported HP 3PAR StoreServ Storage HBAs and hosts also support the HP 3PAR Express Writes feature, and its benefits extend to both spinning drives and flash-based media.

¹Based on a random, 100 percent write workload with an 8K block size.

The HP 3PAR StoreServ 7200 and StoreServ 7400 (2-node and 4-node) storage systems are US Environmental Protection Agency (EPA) ENERGY STAR certified. Details about the specific configurations that are certified are available at the US EPA web site at:

<https://data.energystar.gov/Active-Specifications/ENERGY-STAR-Certified-Data-Center-Storage/gqtf-hp7x?>

Autonomic

It's like breathing-you don't even have to think about it. Simplify, automate, and expedite storage management by handling storage provisioning, tiering, and change management autonomically-intelligently, at a sub-system level, and without administrator intervention.

SmartStart Software - software designed to get you off to a quick start with your new HP 3PAR StoreServ 7000 system.

Common architecture - Access the same features as the world's largest service providers with a common architecture that meets SMB needs and spans to the largest global enterprise.

Standard Features

Resilient

Secure multi-tenancy - Consolidate with confidence. Achieve higher service levels for more users and applications with less infrastructure. HP 3PAR StoreServ Storage is designed to support massive consolidation by supporting mixed workloads and secure administrative segregation of users, hosts, and application data. Deliver higher performance levels, six-nine availability, and next-generation functionality to multiple user groups and applications from a single storage system.

Scalable - HP 3PAR StoreServ 7000 provides affordable entry pricing and unique, non-disruptive scalability to four nodes.

High Availability - With the Get 6-Nines Guarantee, HP ensures 99.9999% data availability with all HP 3PAR StoreServ 7400 systems with four nodes giving you the peace of mind to expand deployment of mission critical applications to midrange storage. Intelligent data striping across all available enclosures provides HA Cage, the ability to maintain availability even when a whole drive enclosure fails. HP 3PAR Persistent Cache in four node configurations eliminates performance impacts that result from unplanned component failures, making it a must-have for maintaining service levels in the virtual data center—a feature that you can't get from any other midrange storage platform.

Storage federation - Meet the needs of today's data center with the ability to move data and workloads between arrays without impact to applications, users, or services. Simply and non-disruptively shift data between any model HP 3PAR StoreServ system without additional management layers or appliances. Storage federation on HP 3PAR StoreServ Storage can also help you improve availability in clustered VMware environments.

Mixed workload - Mixed workload support serves transactional and throughput-intensive workloads from a single device. The purpose-built HP 3PAR ASIC delivers mixed workload support to alleviate performance concerns and cut traditional array costs. Transaction- and throughput-intensive workloads run on the same storage resources without contention, thereby cutting array purchases in half.

Data at Rest Encryption - enables the encryption for all the data that is stored on the internal drives of the 3PAR StoreServ Storage. The 3PAR StoreServ Data Encryption solution encrypts and decrypts all data written to and read from the media automatically. The 3PAR StoreServ Data Encryption solution encrypts the data so that data cannot be read off a drive that is removed from the 3PAR Storage. In the event of a failure of the drive or the theft of a drive, the proper authentication key is required to be entered to gain access to the data stored within the drive. This method of encryption allows the user the comfort knowing all data contained on the drive is protected against internal and external risks.

HP 3PAR StoreServ 7200 All-Flash Starter Kit

HP 3PAR StoreServ 7200c All-Flash Starter Kit

HP 3PAR StoreServ 7200c All-Flash Starter Kit is an all-flash version of the HP 3PAR StoreServ 7200c that provides all-flash acceleration at entry-level price. The kit includes the HP 3PAR StoreServ 7200c Storage System Base equipped with 8 x 480GB SFF cMLC SSD drives and also includes the Reporting Suite and Virtual Copy software.

What's New

- HP 3PAR StoreServ 7200c All-Flash Starter Kit

HP 3PAR StoreServ 7200c All-Flash Starter Kit

The HP 3PAR StoreServ 7200c All-Flash Starter Kit is the solution for mid-range customers that need all-flash acceleration at an affordable price. The kit is an orderable part number that includes, in addition to the HP 3PAR StoreServ 7200c Storage System Base, cMLC SSD drives and Reporting Suite and Virtual Copy software.

The HP 3PAR StoreServ 7200c All-Flash Starter Kit has the same Drive LTUs cap and maximum number of SSDs as the HP 3PAR StoreServ 7200c. The Drive LTUs cap for HP 3PAR StoreServ 7200c All-Flash Starter Kit is 48. After reaching the cap, you do not need to purchase any more Drive LTUs for that title. The maximum number of SSDs is 120.

Model

HP 3PAR StoreServ 7200c All-Flash Starter Kit

K7W06A

The HP 3PAR StoreServ 7200c All-Flash Starter Kit is an orderable part number that includes the following individual parts.

Quantity	Component	
1	HP 3PAR StoreServ 7200c 2-node Field Integrated Storage Base	E7X67A
8	HP M6710 480GB 6G SAS 2.5in cMLC SSD	E7Y55A
1	HP 3PAR 7200 Operating System Software Suite Base LTU	BC745B
8	HP 3PAR 7200 Operating System Software Suite Drive LTU	BC746A
1	HP 3PAR 7200 Reporting Suite Base LTU	BC767B
1	HP 3PAR 7200 Virtual Copy Base LTU	BC753A
8	HP 3PAR 7200 Virtual Copy Drive LTU	BC754A

NOTE: Users can add more SSDs, drive enclosures (and any other 7000 accessory), and software to the HP 3PAR StoreServ 7200 All-Flash Starter Kit quote. Each of the nested components will appear as separate parts on the quote and will be priced accordingly

Service and Support, HP Care Pack, and Warranty Information

Warranty 3 Year, On-site Warranty Service for hardware components. 7x24 4-hour remote response with next business day on-site response

The warranty on the following HP 3PAR StoreServ 7000 SSD product numbers is 5 years, parts only:

HP 3PAR StoreServ M6710 480GB 6G SAS SFF(2.5in) MLC 5yr Wty Solid State Drive	E7W54B
HP 3PAR StoreServ M6720 480GB 6G SAS LFF(3.5in) MLC 5yr Wty Solid State Drive	E7W55B
HP 3PAR StoreServ M6710 920GB 6G SAS SFF(2.5in) MLC 5yr Wty Solid State Drive	E7W24B
HP 3PAR StoreServ M6720 920GB 6G SAS LFF(3.5in) MLC 5yr Wty Solid State Drive	E7W25B
HP 3PAR StoreServ M6710 920GB 6G SAS SFF(2.5in) FIPS Encrypted MLC Solid State Drive	E7Y52A
HP 3PAR StoreServ M6710 480GB 6G SAS SFF(2.5in) cMLC Solid State Drive	E7Y55A
HP 3PAR StoreServ M6720 480GB 6G SAS LFF(3.5in) cMLC Solid State Drive	E7Y56A
HP 3PAR StoreServ M6710 1.92TB 6G SAS SFF(2.5in) cMLC Solid State Drive	E7Y57A
HP 3PAR StoreServ M6720 1.92TB 6G SAS LFF(3.5in) cMLC Solid State Drive	E7Y58A

HP 3PAR StoreServ 7000 drive (SAS performance and Nearline and SSDs excluding the ones listed above) warranty is 3 years, parts only. HP warrants only that the Software media will be free of physical defects for a period of ninety (90) days from delivery

For more information about HP's Global Limited Warranty and Technical Support, visit:

<http://www.hp.com/products/storageworks/warranty>

Service and Support

Technology Services for increased uptime, productivity and ROI

Trust HP storage technology experts for every level of service and support. Our integrated portfolio of services for storage help customers reduce costs, optimize data, streamline storage management, and improve backup and recovery. Capitalizing on HP Storage Systems' capabilities requires a service partner who understands your increasingly complex environment. Team with the people who know HP infrastructure hardware and software best—the experienced professionals at HP Services.

Protect your business beyond warranty

Warranty protects against manufacturer defects, however warranty uplifts, such as HP Care Pack Services protect the business—by reducing downtime risks and providing operational consistency for mission-critical and standard business computing.

NOTE: SSDs have a limited number of writes that can occur before reaching the SSD's write endurance limit. This limit is generally high enough so wear out will not occur during the expected service life of an HP 3PAR StoreServ under the great majority of configurations, IO patterns, and workloads. HP 3PAR StoreServ tracks all writes to SSDs and can report the percent of the total write endurance limit that has been used. This allows any SSD approaching the write endurance limit to be proactively replaced before they are automatically spared out. An SSD has reached the maximum usage limit once it exceeds its write endurance limit. Following the product warranty period, SSDs that have exceeded the maximum usage limit will not be repaired or replaced under HP support contracts.

Service and Support, HP Care Pack, and Warranty Information

What HP Storage Technology Services can do for you

HP Storage Technology Services can help you design, deploy, test, integrate, support, and manage IT and infrastructure solutions. HP storage lifecycle support services offers a full spectrum of customer care—from technology support to complex migrations to complete managed services.

Choose the right level of support, deployment and integration services

HP support recommendations are designed to help you enhance technology operations and lower risk—and make it easier for you to seek the right balance between affordability and service-level commitments. Depending on your individual support needs, choose from three levels of care that cover the entire lifecycle to better address your needs—Optimized Care, Standard Care, and Basic Care. If none of our support recommendations meet your needs, we can tailor a service solution for your unique support requirements. Only HP brings together deep expertise, proactive and business critical support and a strong partner network—together with, a full set of infrastructure services designed to power a Converged Infrastructure

Optimized Care - delivers best performance and stability through deployment and proactive management practices

HP Critical Service - This service delivers 24x7 monitoring of your environment, making it the right choice when uninterrupted uptime is essential. We implement improvement projects to mitigate risks and reduce incidents to maximize uptime. If outages do occur, they will be addressed immediately through access to our dedicated critical support escalation resources, with a six-hour call-to-repair commitment from our mission-critical call center.

Additional Option:

10 Proactive Select credits per year per array - HP Proactive Select is a flexible way to purchase services to fit your particular environment or situation. Working with an HP Account Support Manager, you select a package of services in the form of services credits that include proactive services spanning many technologies and processes, such as on-site firmware upgrades, health checks, assessments, and education. You tailor the service delivery to improve time to production, optimize performance, or build in continuous improvements.

Standard Care - maintains high level of uptime, along with expert help to cut the cost and complexity of implementation and support

HP Proactive Care 24x7 - for a higher return on your storage investment, Proactive Care delivers hardware and software support services designed specifically for your technology; rapid access to Advanced Solution Center Specialists plus, Firmware/Software management and best practice advice. Customers can optimize the return on their IT investment and realize the advantage of running their business critical applications on virtualized infrastructure. Plus, HP Proactive Select 20 credits per year, select from an extensive menu of consultancy and technical services, such as onsite firmware upgrades, health checks, assessments, and education.

Additional Option:

HP Proactive Care Personalized Support - The HP Proactive Care Personalized Support option allows for an increased personalization of the Proactive Care support experience through the assignment of an Account Service Manager (ASM) who provides IT best practice advice to help address IT issues and projects. The ASM will develop an annual support plan, provide four days of operational and technical advice, and conduct semi-annual support reviews to ensure the Proactive Care service deliverables address the customer's priorities. This option is only available for Proactive Care customers and may be purchased once per environment.

HP Personalized Support Additional Day - Customers who require more time than is provided by the Personalized Support option can elect to purchase additional days through the Personalized Support

Service and Support, HP Care Pack, and Warranty Information

Additional Day option. The time may be used to provide extra support reviews and/or more operational & technical advice.

Basic Care - Minimum recommended support

HP Proactive Care 24x7 - for a higher return on your storage investment, Proactive Care delivers hardware and software support services designed specifically for your technology; rapid access to Advanced Solution Center Specialists plus, Firmware/Software management and best practice advice. Customers can optimize the return on their IT investment and realize the advantage of running their business critical applications on virtualized infrastructure. Plus, 10 credits per year, select from an extensive menu of consultancy and technical services, such as onsite firmware upgrades, health checks, assessments, and education.

Additional Option:

HP Proactive Care Personalized Support - The HP Proactive Care Personalized Support option allows for an increased personalization of the Proactive Care support experience through the assignment of an Account Service Manager (ASM) who provides IT best practice advice to help address IT issues and projects. The ASM will develop an annual support plan, provide four days of operational and technical advice, and conduct semi-annual support reviews to ensure the Proactive Care service deliverables address the customer's IT priorities. This option is only available for Proactive Care customers and may be purchased once per environment.

HP Personalized Support Additional Day - Customers who require more time than is provided by the Personalized Support option can elect to purchase additional days through the Personalized Support Additional Day option. The time may be used to provide extra support reviews and/or more operational & technical advice.

Implementation

Installation:

Whichever level of care you select, consider our Installation and Startup Services for a smooth implementation.

HP 3PAR StoreServ 7000 Storage Installation and Startup Service - For smooth startup, this service provides you with deployment of your HP 3PAR StoreServ 7000 Storage, ensuring proper installation into your storage environment and helping you realize the maximum benefit from your storage investment.

<http://h20195.www2.hp.com/V2/GetPDF.aspx/4AA4-2568ENW.pdf>

Related Services

HP Storage Data Migration Service - HP expertise and tools help you migrate data across your data center or around the globe. Take the burden of migration off your shoulders and put it in the capable hands of expert HP storage migration consultants. Our proven approach helps orchestrate the complete data migration and consolidation process while maintaining consistent data availability during the transfer process.

<http://h20195.www2.hp.com/V2/GetPDF.aspx/4AA3-0774ENW.pdf>

HP Enhanced Implementation Service for SANs - HP delivers complete design and implementation services for Fibre Channel, FCoE, FCIP, SAS, and iSCSI storage area network (SAN) connectivity components. This service includes three levels of support based on the type of environment, ranging from simple to more complex. A trained service specialist guides the implementation of the storage switches in the SAN environment according to HP quality standards.

<http://h20195.www2.hp.com/V2/GetPDF.aspx/5981-8527EN.pdf>

HP Data Replication Solution Service for 3PAR Virtual Copy - HP Data Replication Solution Service for HP 3PAR Virtual Copy Software helps create, manage and configure local replication data mirroring

Service and Support, HP Care Pack, and Warranty Information

and snapshot capabilities of 3PAR storage systems. This service enables snapshots and mirroring to facilitate data restores, minimize downtime for backups, perform application testing, support data mining use with decision-support tools.

<http://h20195.www2.hp.com/V2/GetPDF.aspx/4AA4-0217ENW.pdf>

HP Data Replication Solution Service for 3PAR Remote Copy - HP Data Replication Solution Service for 3PAR Remote Copy Software configures real-time data mirroring between local and remote 3PAR storage systems to safeguard critical business information. Provides scalable deployment of HP Remote Copy Software real-time data mirroring between a local and a remote 3PAR storage system.

<http://h20195.www2.hp.com/V2/GetPDF.aspx/4AA3-8627ENW.pdf>

<http://h20195.www2.hp.com/V2/GetPDF.aspx/4AA0-9431ENW.pdf>

HP 3PAR 7000 Replication Software Suite Installation and Startup Service - Provides implementation of the HP 3PAR 7000 Replication Software Suite product. Replication Suite includes 3PAR Remote Copy, 3PAR Virtual Copy, and 3PAR Peer Persistence. The service is designed to help get HP 3PAR 7000 Replication Software Suite up and running quickly and to provide a demonstration of the product's key features using sample or test data only.

<http://h20195.www2.hp.com/V2/GetPDF.aspx/4AA4-2570ENW.pdf>

HP 3PAR Peer Persistence Software Installation and Startup Service - Provides implementation of the HP 3PAR Peer Persistence Software product. The service is designed to help get HP 3PAR Peer Persistence up and running quickly and to provide a demonstration of the product's key features using sample or test data only.

<http://h20195.www2.hp.com/V2/GetPDF.aspx/4AA4-2772ENW.pdf>

HP 3PAR Adaptive Optimization Policy Implementation Service - HP 3PAR Adaptive Optimization Policy Implementation Service provides analysis, recommendations, and implementation of HP 3PAR Adaptive Optimization policies to enable storage tiering using data collected from the HP 3PAR Storage system over time. With the assistance of a designated IT storage administrator, a service specialist works with the customer to implement Adaptive Optimization policies on the HP 3PAR Storage system to help deliver service level optimization for virtual and cloud data centers while reducing cost, increasing agility and minimizing risk.

<http://h20195.www2.hp.com/V2/GetPDF.aspx/4AA2-3842ENW.pdf>

HP Storage Virtual Volume Design and Implementation Service - When redeploying an HP StorageWorks Disk Array, the HP Virtual Volume Design and Implementation Service provides the necessary activities required to design and implement a new virtual volume configuration.

<http://h20195.www2.hp.com/V2/GetPDF.aspx/4AA2-3764ENN.pdf>

HP Thin Volume Conversion Service - Provides evaluation and execution of conversion from standard to thin provisioned virtual volumes for HP 3PAR Storage. A service specialist advises the customer on HP thin provisioning best practices, provides evaluation of potential disk capacity savings if target virtual volumes are converted, and plans and implements thin conversion processing. The service leverages 3PAR thin provisioning capabilities to help optimize storage capacity, reduce cost, increase agility and maintain performance.

<http://h20195.www2.hp.com/V2/GetPDF.aspx/4AA2-3842ENW.pdf>

HP Performance Analysis Service for HP Disk Arrays - The service provides data collection, detailed I/O analysis and enhancement recommendations for HP 3PAR StoreServ Storage disk arrays, HP EVA

Service and Support, HP Care Pack, and Warranty Information

P6000 Storage disk arrays and HP XP P9000 Storage disk arrays. HP Performance Analysis Service for HP Storage Disk Arrays provides a single engagement concerning the performance of a single HP 3PAR StoreServ Storage disk array, HP EVA P6000 Storage disk array and HP XP P9000 Storage disk array <http://h20195.www2.hp.com/V2/GetPDF.aspx/5982-6668EN.pdf>

HP 3PAR Health Check Service - The HP 3PAR Health Check service is delivered as a single engagement, providing data collection, analysis, report creation, and a briefing session concerning the performance of a single HP 3PAR StoreServ Storage System. This health check service is best for HP 3PAR StoreServ Storage Systems that have been installed and are in normal production mode. It can also be used to establish a baseline for future reference to improve the effective use of your storage system.

<http://h20195.www2.hp.com/V2/GetPDF.aspx/4AA4-3225ENW.pdf>

HP 3PAR Storage Assessment Service - The HP 3PAR Assessment Service is delivered remotely for a single HP 3PAR StoreServ Storage System and does not include performance analysis, testing, or modeling. The service requires that remote monitoring be enabled on the HP 3PAR StoreServ Storage System being assessed. The assessment findings are compared to HP best practices and a summary report is provided that includes recommendations intended to improve availability and ongoing management of your HP 3PAR StoreServ Storage System.

<http://h20195.www2.hp.com/v2/GetPDF.aspx/4AA3-2346ENW.pdf>

HP 3PAR Storage Rebalance Service - The HP 3PAR Rebalance Service helps balance data across your HP 3PAR StoreServ Storage to take advantage of the capabilities of the array architecture. The service provides analysis, planning, and implementation of data movement and/or physical movement of drive magazines within the array.

<http://h20195.www2.hp.com/V2/GetPDF.aspx/4AA4-0280ENW.pdf>

HP EVA to 3PAR Acceleration Service - The HP EVA to 3PAR Acceleration Service can help guide you or even execute data migration activities on your behalf that can not only optimize, but provide OPEX and CAPEX savings as a result of your journey from EVA to 3PAR. This service provides customers with an alternative DIY ("do-it-yourself") data migration option with guidance from TS Storage migration specialists. With the help of migration experts, this service allows customers to execute an EVA to 3PAR data migration at their own pace and lowered cost.

<http://h20195.www2.hp.com/V2/GetPDF.aspx/4AA4-4234ENW.pdf>

HP 3PAR Adaptive Optimization I&S - For Adaptive Optimization, design, creation, and implementation of Adaptive Optimization policies; policy design, creation, and implementation can be accommodated using the HP 3PAR Adaptive Optimization Policy Implementation Service, which is available via HP Proactive Select.

The Service has further been described in the HP 3PAR 7000 Software Installation and Startup Service Datasheet: <http://h20195.www2.hp.com/V2/GetPDF.aspx/4AA4-2569ENW.pdf>

HP 3PAR Dynamic Optimization I&S - For Dynamic Optimization, implementation by HP of tasks required to balance the HP 3PAR storage system; the service provides the Customer with a product overview, advice, and suggested strategies for use of Dynamic Optimization, and extended/ongoing analysis and/or implementation of Dynamic Optimization strategies can be accommodated at additional cost

The Service has further been described in the HP 3PAR 7000 Software Installation and Startup Service Datasheet: <http://h20195.www2.hp.com/V2/GetPDF.aspx/4AA4-2569ENW.pdf>

Service and Support, HP Care Pack, and Warranty Information

For more information www.hp.com/services/storage

To learn more on HP Storage Services, please contact your HP sales representative or HP Authorized Channel Partner

HP Care Pack Services are sold by HP and HP Authorized Service Partners:

- Services for customers purchasing from HP or an enterprise reseller are quoted using HP order configuration tools.
- Customers purchasing from a commercial reseller can find HP Care Pack Services at: www.hp.com/go/lookuptool

Configuration Information

Step 1 - Choose a Base configuration

HP 3PAR StoreServ 7000 configurations start with the selection of the Base. The Base includes controller nodes, bays for small form factor drives, and PCIe slots for host adapter cards. SAN Kits are also considered base configurations. The SAN Kits simplify ordering for SAN configurations with the array and extend the switch warranty to 3-years by including switches with an HP 3PAR StoreServ 7000 Storage Base.

HP 3PAR StoreServ 7000 Base Configurations

Factory Integrated in HP rack	HP 3PAR StoreServ 7200c 2-node Storage Base	QR511A
	HP 3PAR StoreServ 7400c 2-node Storage Base	QR512A
	HP 3PAR StoreServ 7400c 4-node Storage Base	QR513A
	HP 3PAR StoreServ 7440c 2-node Storage Base	E7X76A
	HP 3PAR StoreServ 7440c 4-node Storage Base	E7X81A
	HP 3PAR StoreServ 7200 2-node Storage Base	QR482A
	HP 3PAR StoreServ 7400 2-node Storage Base	QR483A
	HP 3PAR StoreServ 7400 4-node Storage Base	QR485A
Factory Integrated in HP rack in a Storage Centric Configuration	HP 3PAR StoreServ 7200c 2-node Storage Base for Storage Centric Rack	E7X65A
	HP 3PAR StoreServ 7400c 2-node Storage Base for Storage Centric Rack	E7X69A
	HP 3PAR StoreServ 7400c 4-node Storage Base for Storage Centric Rack	E7X73A
	HP 3PAR StoreServ 7440c 2-node Storage Base for Storage Centric Rack	E7X78A
	HP 3PAR StoreServ 7440c 4-node Storage Base for Storage Centric Rack	E7X84A
	HP 3PAR StoreServ 7200 2-node Storage Base for Storage Centric Rack	E7W49A
	HP 3PAR StoreServ 7400 2-node Storage Base for Storage Centric Rack	E7W50A
	HP 3PAR StoreServ 7400 4-node Storage Base for Storage Centric Rack	E7W51A
Field Integrated	HP 3PAR StoreServ 7200c 2-node Field Integrated Storage Base	E7X67A
	HP 3PAR StoreServ 7400c 2-node Field Integrated Storage Base	E7X71A
	HP 3PAR StoreServ 7400c 4-node Field Integrated Storage Base	E7X75A
	HP 3PAR StoreServ 7400c 2-node Field Integrated Storage Base	E7X80A
	HP 3PAR StoreServ 7400c 4-node Field Integrated Storage Base	E7X86A
	HP 3PAR StoreServ 7200 2-node Storage Base	QR482A
	HP 3PAR StoreServ 7400 2-node Storage Base	QR483A
	HP 3PAR StoreServ 7400 4-node Storage Base	QR485A
	HP 3PAR StoreServ 7200 Storage System Flash Starter Kit	K2Q09A
	HP 3PAR StoreServ 7200 8Gb H-series Base System SAN Kit	QR488A
	HP 3PAR StoreServ 7200 16Gb Virtualization Base System SAN Kit	QR489A
	HP 3PAR StoreServ 7400 16Gb Virtualization Base System SAN Kit	QR510A

Configuration Information

- A minimum of one (1) configuration base must be ordered.
- The HP 3PAR StoreServ 7200c base configuration includes (2) controller nodes, 40 GB of cache, (24) small form factor drive bays, (4) built-in 8 Gb/sec FC ports, (4) 8Gb shortwave FC SFP, (2) PCIe adapter slots for host adapter cards - one slot per node, (4) 2m SAS cables, (1) mounting rail kit, and power cords.
- The HP 3PAR StoreServ 7400c 2N base configuration includes (2) controller nodes, 48 GB of cache, (24) small form factor drive bays, (4) built-in 8 Gb/sec FC ports, (4) 8Gb shortwave FC SFP, (2) PCIe adapter slots for host adapter cards - one slot per node, (4) 2m SAS cables, (2) 1U rack filler panels to reserve 2U of rack space above the 2-node Storage Base for a future upgrade to a 4-node configuration, (1) mounting rail kit, and power cords.
- The HP 3PAR StoreServ 7400c 4N base configuration includes (4) controller nodes, 96 GB of cache, (48) small form factor drive bays, (8) built-in 8 Gb/sec FC ports, (8) 8Gb shortwave FC SFP, (4) PCIe adapter slots for host adapter cards - one slot per node, (8) 2m SAS cables, (4) node link cables, (2) mounting rail kits, and power cords.
- The HP 3PAR StoreServ 7440c 2N base configuration includes (2) controller nodes, 96 GB of cache, (24) small form factor drive bays, (4) built-in 8 Gb/sec FC ports, (4) 8Gb shortwave FC SFP, (2) PCIe adapter slots for host adapter cards - one slot per node, (4) 2m SAS cables, (2) 1U rack filler panels to reserve 2U of rack space above the 2-node Storage Base for a future upgrade to a 4-node configuration, (1) mounting rail kit, and power cords.
- The HP 3PAR StoreServ 7440c 4N base configuration includes (4) controller nodes, 192 GB of cache, (48) small form factor drive bays, (8) built-in 8 Gb/sec FC ports, (8) 8Gb shortwave FC SFP, (4) PCIe adapter slots for host adapter cards - one slot per node, (8) 2m SAS cables, (4) node link cables, (2) mounting rail kits, and power cords.
- The HP 3PAR StoreServ 7200 base configuration includes (2) controller nodes, 24 GB of cache, (24) small form factor drive bays, (4) built-in 8 Gb/sec FC ports, (4) 8Gb shortwave FC SFP, (2) PCIe adapter slots for host adapter cards - one slot per node, (4) 2m SAS cables, (1) mounting rail kit, and power cords.
- The HP 3PAR StoreServ 7400 2-node base configuration includes (2) controller nodes, 32 GB of cache, (24) small form factor drive bays, (4) built-in 8 Gb/sec FC ports, (4) 8Gb shortwave FC SFP, (2) PCIe adapter slots for host adapter cards - one slot per node, (4) 2m SAS cables, (2) 1U rack filler panels to reserve 2U of rack space above the 2-node Storage Base for a future upgrade to a 4-node configuration, (1) mounting rail kit, and power cords.
- The HP 3PAR StoreServ 7400 4-node base configuration includes (4) controller nodes, 64 GB of cache, (48) small form factor drive bays, (8) built-in 8 Gb/sec FC ports, (8) 8Gb shortwave FC SFP, (4) PCIe adapter slots for host adapter cards - one slot per node, (8) 2m SAS cables, (4) node link cables, (2) mounting rail kits, and power cords.
- The HP 3PAR StoreServ 7200 8Gb H-Series Base System SAN Kit includes the QR482A HP 3PAR StoreServ 7200 2-node Storage Base, (2) BK780B HP

Configuration Information

SN6000 Stackable 8 Gb/s 8 Active Port Single Power Supply FC Switches and (4) TA821A 4-port FC Switch Upgrade LTUs. Each switch comes with serial cable, mounting rail kits, power cords, and SAN Connection Manager software entitlement. Also included is a 3 year warranty for the switches.

NOTE: Requires optical transceivers and switch cabling which must be supplied separately.

- The HP 3PAR StoreServ 7200 16Gb Virtualization Base System SAN Kit includes the HP 3PAR StoreServ 7200 2-node Storage Base and (2) QK753B HP SN6000B 16 Gb/s 48-port/24-port Active FC Switches - dual power. Each switch comes with rack mount kit (including rails, mounting hardware, and plenum), RJ-45 serial cable with adaptor for RJ-45 to DB9, power cords, and SAN Network Advisor DVD. Also included is a 3 year warranty for the switches.
NOTE: Requires optical transceivers and switch cabling which must be supplied separately.
- The HP 3PAR StoreServ 7400 16Gb Virtualization Base System SAN Kit includes the HP 3PAR StoreServ 7400 2-node Storage Base and (2) QK753B HP SN6000B 16 Gb/s 48-port/24-port Active FC Switches -dual power. Each switch comes with rack mount kit (including rails, mounting hardware, and plenum), RJ-45 serial cable with adaptor for RJ-45 to DB9, power cords, and SAN Network Advisor DVD. Also included is a 3 year warranty for the switches.
NOTE: Requires optical transceivers and switch cabling which must be supplied separately.
- All base configurations include built-in Gigabit Ethernet ports for management and Remote Copy over IP.

*Storage Centric Configuration

- The Storage Centric rack versions of HP 3PAR StoreServ 7200 and 7400 are for CTO (factory Configure-To-Order) only. With a Storage Centric configuration, the storage system gets placed in the center of the rack so that future expansion of that storage system becomes easier.
- In Storage Centric configurations, non-3PAR components, with the exception of certain StoreFabric Storage Networking switches, if added to the same order, get placed in a separate rack.

The following diagrams show a HP 3PAR StoreServ 7400c 4N Storage System in Storage Centric and non-Storage Centric configurations

Configuration Information

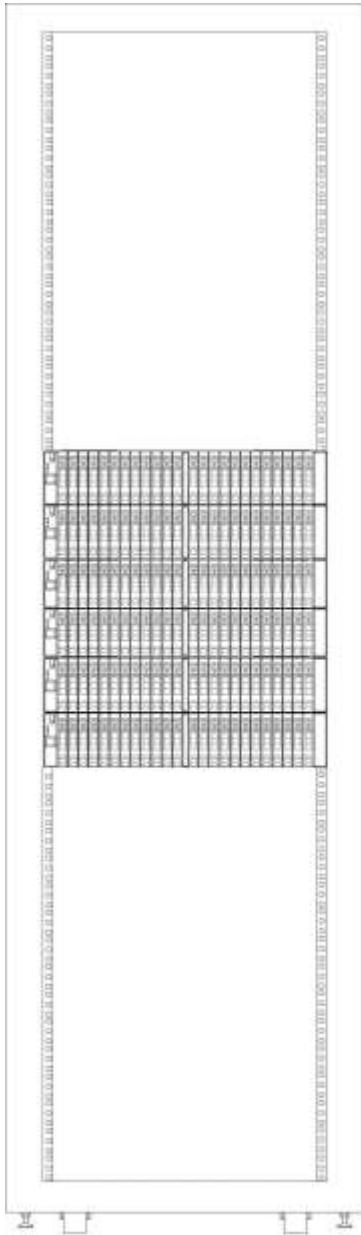

StoreServ 7400c 4N Storage system in a storage centric configuration in a HP Intelligent Series Rack

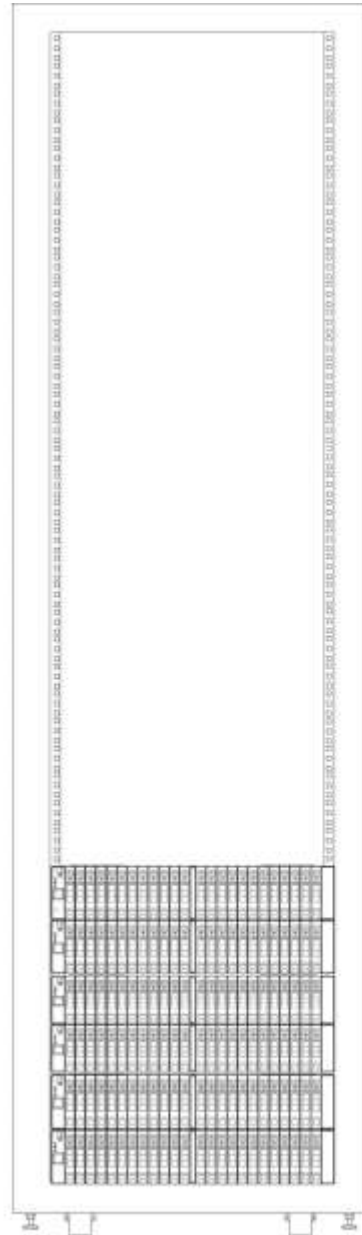

StoreServ 7400c 4N Storage system in a non-storage centric configuration in a HP Intelligent Series Rack

HP 3PAR StoreServ 7000 Upgrade Controller Node Pair

Use the HP 3PAR StoreServ 7400c Upgrade Node Pair to convert an existing previously installed HP 3PAR StoreServ 7400c 2N Storage Base into a 4-node configuration.

HP 3PAR StoreServ 7400c Upgrade Node Pair

QR515A

- Used to upgrade the E7X71A HP 3PAR StoreServ 7400c 2N Storage Base to a 4-node configuration.
- One (1) pair of controller nodes beyond the base configuration is supported

Configuration Information

- on the 3PAR StoreServ 7400c.
- The 3PAR StoreServ 7400c Upgrade Node Pair includes (2) controller nodes, 48 GB of cache, (24) small form factor drive bays, (4) built-in 8 Gb/sec FC ports, (4) 8Gb shortwave FC SFP, (2) PCIe adapter slots for host adapter cards - one slot per node, (4) 2m SAS cables, (4) node link cables, (1) mounting rail kit, and power cords
- The upgrade node pair includes built-in Gigabit Ethernet ports for management and Remote Copy over IP.

Use the HP 3PAR StoreServ 7440c Upgrade Node Pair to convert an existing previously installed HP 3PAR StoreServ 7440c 2N Storage Base into a 4-node configuration.

HP 3PAR StoreServ 7440c Upgrade Node Pair

E7X83A

- Used to upgrade the E7X80A HP 3PAR StoreServ 7440c 2N Storage Base to a 4-node configuration.
- One (1) pair of controller nodes beyond the base configuration is supported on the 3PAR StoreServ 7440c.
- The 3PAR StoreServ 7440c Upgrade Node Pair includes (2) controller nodes, 48 GB of cache, (24) small form factor drive bays, (4) built-in 8 Gb/sec FC ports, (4) 8Gb shortwave FC SFP, (2) PCIe adapter slots for host adapter cards - one slot per node, (4) 2m SAS cables, (4) node link cables, (1) mounting rail kit, and power cords
- The upgrade node pair includes built-in Gigabit Ethernet ports for management and Remote Copy over IP.

Use the HP 3PAR StoreServ 7400 Upgrade Node Pair to convert an existing previously installed HP 3PAR StoreServ 7400 2N Storage Base into a 4-node configuration.

HP 3PAR StoreServ 7400 Upgrade Node Pair

QR484A

- Used to upgrade the QR483A HP 3PAR StoreServ 7400 2N Storage Base to a 4-node configuration.
- One (1) pair of controller nodes beyond the base configuration is supported on the 3PAR StoreServ 7400.
- The 3PAR StoreServ 7400 Upgrade Node Pair includes (2) controller nodes, 32 GB of cache, (24) small form factor drive bays, (4) built-in 8 Gb/sec FC ports, (4) 8Gb shortwave FC SFP, (2) PCIe adapter slots for host adapter cards - one slot per node, (4) 2m SAS cables, (4) node link cables, (1) mounting rail kit, and power cords
- The upgrade node pair includes built-in Gigabit Ethernet ports for management and Remote Copy over IP.

Step 2 - Choose Host Adapter

Host adapters can be ordered separately to be installed in the field or they can be factory configured into controller nodes. Host adapter cards provide the array with additional FC ports or with 10Gb/sec iSCSI/FCoE ports. The additional FC ports can be used for connection to hosts or used to connect to other HP 3PAR StoreServ Storage systems in a Remote Copy relationship. The iSCSI/FCoE ports permit host connection in iSCSI and FCoE environments.

NOTE: Ethernet Adapters can be used only with the [HP 3PAR File Persona Software Suite for File services connectivity](#).

Configuration Information

HP 3PAR StoreServ 7000 Host Adapters

HP 3PAR StoreServ 7000 4-port 8Gb/sec Fibre Channel Adapter	QR486A
HP 3PAR StoreServ 7000 2-port 10Gb/sec iSCSI/FCoE Adapter	QR487A
HP 3PAR StoreServ 7000 2-port 16Gb/s Fibre Channel Adapter	E7X47A
HP 3PAR StoreServ 7000 2-port 10Gb/s Ethernet Adapter	E7X96A
HP 3PAR StoreServ 7000 4-port 1Gb/s Ethernet Adapter	E7X97A

- Fibre Channel (QR486A, E7X47A) and iSCSI/FCoE Adapters (QR487A) are used in the Storage Base products (E7X67A, E7X71A, E7X75A, E7X80A, E7X86A, QR482A, QR483A, and QR485A) and the Upgrade Node Pair (QR515A, E7X83A, and QR484A).
- Ethernet Adapters (E7X96A, E7X97A) can be used exclusively with the HP 3PAR File Persona Software Suite on the HP 3PAR StoreServ 7200c, 7400c, and 7440c Storage Base products (E7X67A, E7X71A, E7X75A, E7X80A, E7X86A) and Upgrade Node Pair (QR515A, E7X83A).
- Because the Storage Base products and the Upgrade Node Pair include built-in FC ports, the host adapter cards are optional.
- QR486A and QR487A include one adapter card each. Adapters must be purchased in pairs.
- The QR486A includes (4) 8 Gb/s shortwave FC SFPs and the QR487A includes (2) 10 Gb/s SFPs.
- Each node in a node pair (a node pair is composed of the two controller nodes in a single 2U enclosure) must have the same number and type of adapters. FC, iSCSI/FCoE, and GbE adapters may not be intermixed in a node pair.
- The 4 ports of the FC adapter can be individually configured to connect to a host or to a remote array in an RC configuration.
- The two ports of the iSCSI/FCoE adapter can be individually configured by the user as iSCSI or FCoE.

Adapter Configurations permitted on all HP 3PAR StoreServ 7000 systems										
Product	Nodes	A*	B*	C*	D	E	F*	G	H*	I*
E7X67A E7X71A E7X80A QR482A QR483A	Node 0 Node 1	Empty Empty	FC FC	iSCSI/FCoE iSCSI/FCoE						
QR515A E7X83A QR484A	Node 2 Node 3	Empty Empty	FC FC	iSCSI/FCoE iSCSI/FCoE						
E7X75A E7X86A QR485A	Node 0 Node 1 Node 2 Node 3	Empty Empty Empty Empty	FC FC Empty Empty	iSCSI/FCoE iSCSI/FCoE Empty Empty	Empty Empty FC FC	Empty Empty iSCSI/FCoE iSCSI/FCoE	FC FC iSCSI/FCoE iSCSI/FCoE	iSCSI/FCoE iSCSI/FCoE FC FC	FC FC FC FC	iSCSI/FCoE iSCSI/FCoE iSCSI/FCoE iSCSI/FCoE

* Factory default configurations for given quantities of adapters.

Configuration Information

NOTE: If the configuration includes Remote Copy over Fibre Channel it is recommended that optional Fiber Channel HBAs are purchased as the built in ports will not offer sufficient connectivity.

Ethernet Adapter Configurations permitted on HP 3PAR StoreServ 7200c, 7400c, 7440c									
Product	Nodes	A*	B*	C	D	E	F*	G*	H*
E7X67A	Node 0	Empty	Eth						
E7X71A	Node 1	Empty	Eth						
E7X80A	Node 1	Empty	Eth						
QR515A	Node 2	Empty	Eth						
E7X83A	Node 3	Empty	Eth						
E7X75A	Node 0	Empty	Eth	Empty	Eth	Eth	FC	iSCSI/FCoE	Eth
E7X71A	Node 1	Empty	Eth	Empty	Eth	Eth	FC	iSCSI/FCoE	Eth
E7X86A	Node 2	Empty	Empty	Eth	FC	iSCSI/FCoE	Eth	Eth	Eth
E7X80A	Node 3	Empty	Empty	Eth	FC	iSCSI/FCoE	Eth	Eth	Eth

* Factory default configurations for given quantities of adapters.

NOTE: If the configuration includes Remote Copy over Fibre Channel it is recommended that optional Fiber Channel HBAs are purchased as the built in ports will not offer sufficient connectivity.

NOTE: Ethernet Adapters can be used only with the HP 3PAR File Persona Software Suite for File services connectivity available on HP 3PAR StoreServ 7200c, 7400c, 7440c

Step 3 - Choose Drive Enclosures

Add drive enclosures to expand the configuration and to add large form factor drives to the configuration. Drive enclosures can be ordered separately for installation in the field, or they can be factory configured in a rack. Drive enclosures are optional. Because the Storage Base products and the Upgrade Node Pair include small form factor drive bays, the minimum configuration does not require any additional drive enclosures. For larger configurations, attach drive enclosures. Each drive enclosure includes 24 drive bays. The HP 3PAR StoreServ 7200 and 7200c support up to nine (9) added drive enclosures. The HP 3PAR StoreServ 7400 supports up to eighteen (18) added drive enclosures. The HP 3PAR StoreServ 7400c supports up to twenty-two (22) added drive enclosures. The HP 3PAR StoreServ 7440c supports up to thirty-eight (38) added drive enclosures. The two drive enclosure types can be intermixed in a single array.

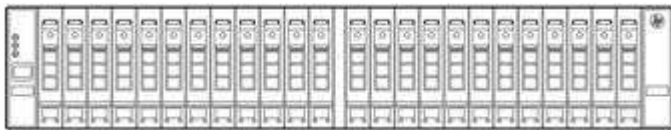

HP M6710 2.5 inch 2U SAS Drive Enclosure

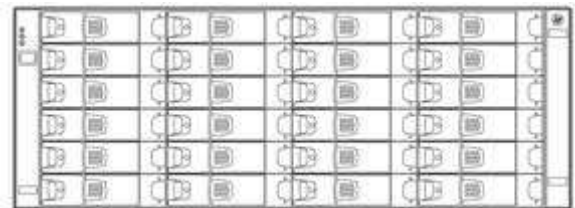

HP M6720 3.5 inch 4U SAS Drive Enclosure

Drive Enclosures

HP M6710 2.5 inch 2U SAS Drive Enclosure	QR490A
HP M6720 3.5 inch 4U SAS Drive Enclosure	QR491A
HP M6710 SFF(2.5in) SAS Field Integrated Drive Enclosure	E7X64A
HP M6720 LFF(3.5in) SAS Field Integrated Drive Enclosure	E7X66A

- Each drive enclosure includes 24 drive bays, (2) IO modules, (2) 1m SAS cables, (1) mounting rail kit, and power cables.
- The M6710 2U drive enclosure provides 24 SFF drive bays arranged in a single row.
- The M6720 4U drive enclosure provides 24 LFF drive bays, arranged in four

Configuration Information

- (4) columns of six (6) slots each.
- Minimum of zero (0) drive enclosures, maximum of five (5) attached to QR482A.
- Minimum of zero (0) drive enclosures, maximum of nine (9) attached to QR483A.
- Minimum of zero (0) drive enclosures, maximum of (18) attached to QR485A.
- Drive enclosures are connected in daisy chains from the SAS ports of the controller nodes.
- The best practice is to balance the drive enclosures across the SAS ports, remembering that the controller node enclosures include (24) drives attached to the SAS port labeled DP-1.
- The best practice when including LFF and SFF drive enclosures in the same array is to arrange them in the rack so that all of the 2U enclosures that belong to one node pair are together and all of the 4U enclosures for that node pair are together. When connecting the backend SAS cables, intermix the M6710 and M6720 enclosures on each SAS port.
- With a four node configuration, the best practice is to attach the same number of drive enclosures to each node pair.
- To achieve highest availability in multi-enclosure configurations, configure a minimum of two (2) enclosures per node pair for RAID 1, a minimum of four (4) enclosures per node pair if RAID 5 is included, and a minimum of three (3) enclosures per node pair if RAID 6 is included. Include enclosures containing node pairs in the count with the M6710 enclosures.
- Drive bays that are not filled with a drive must be covered with a drive blank to preserve proper air flow.
- If future capacity upgrades are expected, include enough Drive Enclosures so that there are some empty bays in each enclosure after all drives are added.

Step 4 - Choose Drives

Drives are orderable at the time the array is purchased, or can be added in the future when additional capacity is required. Unlike other HP 3PAR StoreServ Storage systems where drives are sold in magazines of four, HP 3PAR StoreServ 7000 drives are sold as single drives. Note that these drives are only compatible with the M6710 and M6720 drive enclosures.

HP 3PAR StoreServ 7000 SAS Drives

HP 3PAR SSDs	HP 3PAR StoreServ M6710 480GB 6G SAS SFF(2.5in) MLC 5yr Wty Solid State Drive	E7W54B
	HP 3PAR StoreServ M6720 480GB 6G SAS LFF(3.5in) MLC 5yr Wty Solid State Drive	E7W55B
	HP 3PAR StoreServ M6710 480GB 6G SAS SFF(2.5in) cMLC Solid State Drive	E7Y55A
	HP 3PAR StoreServ M6720 480GB 6G SAS LFF(3.5in) cMLC Solid State Drive	E7Y56A
	HP 3PAR StoreServ M6710 920GB 6G SAS SFF(2.5in) MLC 5yr Wty Solid State Drive	E7W24B
	HP 3PAR StoreServ M6720 920GB 6G SAS LFF(3.5in) MLC 5yr Wty Solid State Drive	E7W25B
	HP 3PAR StoreServ M6710 1.92TB 6G SAS SFF(2.5in) cMLC Solid State Drive	E7Y57A
	HP 3PAR StoreServ M6720 1.92TB 6G SAS LFF(3.5in) cMLC Solid State Drive	E7Y58A

HP 3PAR SAS HDDs	HP M6710 300GB 6G SAS 15K rpm SFF (2.5-inch) Hard Drive	QR492A
-------------------------	---	--------

Configuration Information

(Performance HDDs)	HP M6710 450GB 6G SAS 10K rpm SFF (2.5-inch) Hard Drive	QR494A
	HP 3PAR StoreServ M6710 600GB 6Gb SAS 10K SFF(2.5-inch) HDD	C8R72A
	HP M6710 900GB 6G SAS 10K rpm SFF (2.5-inch) Hard Drive	QR496A
	HP 3PAR StoreServ M6710 1.2TB 6G SAS 10K SFF(2.5in) Hard Drive	E7X49A

HP 3PAR NL SAS HDDs	HP 3PAR StoreServ M6710 1TB 6Gb SAS 7.2K SFF(2.5-inch) Nearline HDD	QR498A
	HP M6720 2TB 6G SAS 7.2K LFF (3.5-inch) Nearline Hard Drive	QR499A
	HP M6720 3TB 6G SAS 7.2K LFF (3.5-inch) Nearline Hard Drive	QR500A
	HP 3PAR StoreServ M6720 4TB 6G 7.2K LFF(3.5-in) SAS Nearline Hard Drive	H6Z87A
	HP 3PAR StoreServ M6720 6TB 6G SAS 7.2K LFF(3.5in) Nearline Hard Drive	K0F28A

- For each drive type installed in the array, the minimum recommended initial quantity is
 - SSD and SAS performance HDDs - eight (8) drives* per node pair
 - Nearline HDDs - twelve (12) drives per node pair
- Minimum upgrade quantity is 4 drives per node pair or 2 drives per enclosure, whichever is larger. Best practice is to run Autonomic Rebalance (also known as tunesys) after adding the drives.
- RAID 6 is strongly recommended for Nearline drives.
- All node enclosures must contain either zero (0) or an even number of drives. All drive enclosures must contain an even number of drives, with a minimum of two.
- Minimum raw capacity is 1.2TB per node pair.
- A best practice is to add equal numbers of drives to all enclosures compatible with the drive type being added.
- With a four node configuration, the best practice is to attach the same number and type of drives to each node pair.
- Small Form Factor (SFF)-specific configuration practices
 - SFF drives may be loaded into the Storage Base enclosures, the Upgrade Node Pair enclosure and the M6710 drive enclosure.
 - SFF drives must be loaded in pairs of identical drives, beginning with the leftmost slot, slot 0, and filling to the right, leaving no empty slots between drives.
- Large Form Factor (LFF)-specific configuration practices
 - LFF drives may be loaded into the M6720 drive enclosure.
 - LFF drives must be loaded in pairs of identical drives starting at the bottom of a column, leaving no empty slots between drives in the column. Columns of drives in the M6720 enclosure must be of the same type (SSD or NL) and, for HDDs, the same rotational speed. Drives of different types may not be mixed in a single column. It is permitted to have empty columns between columns containing drives. Different columns do not have to contain the same number of drives.
 - An all LFF drive configuration is permitted, leaving the Storage Base Enclosure empty.
- SSD specific configuration practices
 - SSD-only configurations are permitted.
 - Maximum of 120 SSDs per node pair.

Configuration Information

- The SFF and LFF SSDs allow the user to create SSD volumes that stripe across SFF and LFF enclosures.
- * 8 drives support RAID 1 and RAID 5. For RAID 6 choose 12 drives.

HP 3PAR Encryption SSD/HDD/LTU

HP 3PAR StoreServ M6710 920GB 6G SAS SFF(2.5in) FIPS Encrypted MLC Solid State Drive	E7Y52A
HP 3PAR StoreServ M6710 450GB 6G SAS 10K SFF(2.5in) FIPS Encryption Hard Drive	C8R59B
HP 3PAR StoreServ M6710 900GB 6G SAS 10K SFF(2.5in) FIPS Encryption Hard Drive	C8R60B
HP 3PAR StoreServ M6710 1TB 6Gb SAS 7.2K SFF(2.5-inch) Nearline Encryption HDD	C8R58A
HP 3PAR StoreServ M6720 2TB 6G SAS 7.2K LFF(3.5in) Nearline FIPS Encryption HDD	H6Z84A
HP 3PAR StoreServ M6720 4TB 6G SAS 7.2K LFF(3.5in) Nearline FIPS Encryption HDD	H6Z86A
HP 3PAR StoreServ 7200 Data at Rest Encryption LTU	BC983A
HP 3PAR StoreServ 7200 Data at Rest Encryption E-LTU	BC983AAE
HP 3PAR StoreServ 7400 Data at Rest Encryption LTU	BC984A
HP 3PAR StoreServ 7400 Data at Rest Encryption E-LTU	BC984AAE
HP 3PAR 7440c Data Encryption LTU	BD406A
HP 3PAR 7440c Data Encryption E-LTU	BD406AAE

Notes:

- All drives within a 3PAR StoreServ encrypted array must be self-encrypted devices. There cannot be a mixture of encrypted drives and non-encrypted drives within the same encrypted array.
- Customers have option to turn on encryption, non-disruptively, at any time; even after data has been written to the system.
- * FIPS 140-2 Validated Self-Encrypting Drives (SEDs) have been certified by the U.S. National Institute of Standards and Technology (NIST) and Canadian Communications Security Establishment (CSE) as meeting the Level 2 security requirements for cryptographic modules as defined in the Federal Information Processing Standards (FIPS) 140-2 Publication *
- Strengthen the DAR solution with an optional FIPS 140-2 Level-2 validated external key manager. Supports KMIP 1.1 for key management communications
- Supports HP Enterprise Secure Key Manager 4.0 and SafeNet KeySecure k460 and k150 centralized key management
- A data encryption license (LTU) is required to enable encryption on the array. One encryption license is required for each encrypted array.
- Once encryption is enabled on the HP 3PAR StoreServ Storage, it cannot be disabled.
- The local key manager is included in the HP 3PAR OS. There is not a separately orderable part number for the local key manager.
- The HP 3PAR 7200/7400 Data at Rest Encryption LTU are valid for both the HP 3PAR StoreServ 7200/7400 and HP 3PAR StoreServ 7200c/7400c Storage systems.
- The HP 3PAR 7440c Data at Rest Encryption LTU are valid only for the HP

Configuration Information

3PAR StoreServ 7440c Storage system.

Step 5 - Choose Service Processor Implementation

The HP 3PAR Service Processor remotely monitors the HP 3PAR StoreServ 7000 and enables remote servicing of the array. The key capabilities of the Service Processor are to:

- Enable rapid, proactive responses to issues
- Provide a secure communication channel between the customer's data center and HP 3PAR Central for:
 - Remote Online Software Upgrade --Upgrade software with no application disruption
 - Remote Diagnostics --Maintain key diagnostic information centrally on a historical basis
 - Remote Serviceability--Provide fast predictive response and remediation

Each HP 3PAR StoreServ 7000 requires its own Service Processor. The Service Processor functions as the communication interface between a customer's IP network and HP 3PAR Central by managing all service-related communications. The Service Processor leverages the industry-standard HTTP over Secure Sockets Layer (HTTPS) protocol to secure and encrypt data communication.

The Service Processor can be deployed either as a virtual Service Processor (VSP) or a physical Service Processor. A virtual Service Processor is included free with the base HP 3PAR Operating System. The virtual Service Processor can be installed on a customer-provided VMware or Microsoft Hyper-V system that meets the following specifications:

- Virtualization operating system
 - VMware vSphere ESXi 4.1, 5.0, 5.1, 5.5
 - Microsoft Hyper-V Server 2008 R2, 2012 or 2012 R2
- Server features
 - 2 GB RAM (minimum for the VSP Virtual Machine)
 - 256 GB free disk space (minimum for the VSP Virtual Machine)
NOTE: VSP storage must not reside on the array it is managing.
 - DVD ROM or DVD RW
 - 1 Gb Ethernet port
 - For VSP on VMware, the server must be listed in the VMware Compatibility Guide
 - For VSP on Hyper-V, the server must be listed on the Windows Server Catalog

If a physical Service Processor is desired, order the following product.

Physical Service Processor

HP 3PAR 7000 Service Processor

QR516B

The physical Service Processor is a dedicated storage appliance located within the storage rack providing close proximity to the HP 3PAR StoreServ 7000 Storage. The physical Service Processor is fully supported and maintained by HP Services. The physical Service Processor has serial port connectivity that provides maintenance access for trouble shooting capabilities. If a VMware server is not available to run the virtual Service Processor, the physical Service Processor is the alternative choice for remote monitoring and remote service.

HP 3PAR Policy Server

HP 3PAR Policy Server works to implement customer-configurable remote service access policies. Installed on a customer-provided host, Policy Server provides the customer with ultimate flexibility and control to allow or deny outbound communication or remote service connections to and from an HP 3PAR StoreServ Storage system. Policy Server also serves as the centralized

Configuration Information

point for collecting and storing audit logs of all diagnostic data transfers and authorized remote service connections to and from all configured HP 3PAR Storage systems. HP 3PAR Policy Server provides the

- The customer has complete control over policy administration.
- A centralized policy administration for all HP 3PAR Storage systems is provided.
- A centralized audit log to facilitate security audits is provided.
- Up to 100 3PAR systems can be managed with a single 3PAR Policy Server license
- Policy Server 6.1.5 can be run on a Virtual Machine. For the latest information on supported hypervisors, refer to Single Point of Connectivity Knowledge for HP Storage Products (SPOCK): <http://www.hp.com/storage/spock>

HP 3PAR Policy Manager Software LTU

TE400B

Step 6 - Choose Cables for host connection and remote copy connection

The optical cables listed below support 8 Gb/s FC and 10 Gb/s iSCSI/FCoE for host connect (FC and iSCSI/FCoE) and for Remote Copy connections (FC only). The copper 1GbE cables are used for Remote Copy over IP and for connection to the Management Port.

Cables

FC and 10GbE

HP 3PAR 4m 50/125 (LC-LC) Fiber Cable	QL281B
HP 3PAR 6m 50/125 (LC-LC) Fiber Cable	QR631A
HP 3PAR 10m 50/125 (LC-LC) Fiber Cable	QL266B
HP 3PAR 25m 50/125 (LC-LC) Fiber Cable	QR593A
HP 3PAR 50m 50/125 (LC-LC) Fiber Cable	QL267B
HP 3PAR 100m 50/125 (LC-LC) Fiber Cable	QL268B
HP Premier Flex LC/LC Multi-mode OM4 2 fiber 1m Cable	QK732A
HP Premier Flex LC/LC Multi-mode OM4 2 fiber 2m Cable	QK733A
HP Premier Flex LC/LC Multi-mode OM4 2 fiber 5m Cable	QK734A
HP Premier Flex LC/LC Multi-mode OM4 2 fiber 15m Cable	QK735A
HP Premier Flex LC/LC Multi-mode OM4 2 fiber 30m Cable	QK736A
HP Premier Flex LC/LC Multi-mode OM4 2 fiber 50m Cable	QK737A

1GbE

HP 4.3m/14ft CAT5 RJ45 M/M Ethernet Cable	C7536A
HP 7.6m/25ft CAT5 RJ45 M/M Ethernet Cable	C7537A
HP 15.2m/50ft CAT5 RJ45 M/M Ethernet Cable	C7542A

Direct Attach Copper Cables*

HP 3COM

HP X240 10G SFP+ to SFP+ 0.65m Direct Attach Copper Cable	JD095C
HP X240 10G SFP+ to SFP+ 1.2m Direct Attach Copper Cable	JD096C
HP X240 10G SFP+ to SFP+ 3m Direct Attach Copper Cable	JD097C
HP X240 10G SFP+ to SFP+ 5m Direct Attach Copper Cable	JG081C
HP X240 10G SFP+ SFP+ 7m Direct Attach Copper Cable	JC784C

HP ProCurve

HP X242 10G SFP+ to SFP+ 1m Direct Attach Copper Cable	J9281B
HP X242 10G SFP+ to SFP+ 3m Direct Attach Copper Cable	J9283B
HP X242 10G SFP+ to SFP+ 7m Direct Attach Copper Cable	J9285B

Configuration Information

HP X242 10G SFP+ to SFP+ 10m Direct Attach Copper Cable	J9286B
HP X242 10G SFP+ to SFP+ 15m Direct Attach Copper Cable	J9287B
Brocade	
HP B-series SFP+ to SFP+ Active Copper 1.0m Direct Attach Cable	AP818A
HP B-series SFP+ to SFP+ Active Copper 3.0m Direct Attach Cable	AP819A
HP B-series SFP+ to SFP+ Active Copper 5.0m Direct Attach Cable	AP820A
Cisco	
HP C-series SFP+ to SFP+ Active Copper 7.0m Direct Attach Cable	QK701A
NOTE: The Direct Attach Support is available only for iSCSI protocol and is available only with HP 3PAR OS version 3.1.3 and later	

Step 7 - Choose Racking Options

The HP 3PAR StoreServ 7000 is compatible with most industry standard 4-post EIA 19 inch racks with square mounting holes, including the HP Intelligent Series Rack and the HP 10000 G2 Series Rack. The HP 3PAR StoreServ 7000 can be factory configured and shipped in a rack or shipped without a rack for field integration into an existing rack. The rack used for factory integration is the HP Intelligent Series Rack.

HP Rack and Rack Options

Factory Integration Select a rack to house your HP 3PAR StoreServ 7000.
Primary Configuration Rules **NOTE:** The HP Intelligent Series Rack is the only series supported for factory configuration.
 The HP 3PAR StoreServ 7000 will be configured into an HP Intelligent Series Rack with the appropriate power distribution units (PDUs). If other products such as servers or back-up products are included in the cab, a different PDU will be added (if required) or can be chosen from a list of appropriate offerings shown in the configuration tool. The HP Intelligent Series Rack must be purchased for factory configuration. Additional 3PAR StoreServ 7000 controller node enclosures and drive enclosures may be ordered for multiple subsystem integration at the factory.
 The 3PAR StoreServ 7000 is also supported in HP 10000 G2 Series racks for field installation. When calculating available U-space, assume that no space will be placed between the mounted components. For redundancy, order PDUs in quantities of two. Refer to the Configuration and User Guide in the Information Library at the Rack Solutions webpage.

HP Intelligent Series Racks **NOTE:** The number of components that will fit in a rack varies and is determined by the interior U-space of the rack.

HP 647 1075mm Shock Intelligent Series Rack	BW912A
HP 47U 1075mm Side Panel Kit	BW915A
HP 642 1075mm Shock Intelligent Series Rack	BW904A
HP 42U 1075mm Side Panel Kit	BW906A
HP 636 1075mm Shock Intelligent Series Rack	BW896A
HP 36U 1075mm Side Panel Kit	BW898A

For more information on the HP rack offerings, please see the following URL:

<http://h18004.www1.hp.com/products/servers/platforms/rackandpower.html>.

For more information on rack options, see: <http://www.hp.com/products/rackoptions>.

For more information on PDUs, see:

Configuration Information

<http://h18004.www1.hp.com/products/servers/proliantstorage/power-protection/pdu.html>.

HP PDU Pivot Kit HP EVA PDU Pivot Kit AG730A

Used to reclaim 2U of space in an HP Intelligent Series Rack with HP 3PAR StoreServ 7000 configurations. This kit allows the PDUs to be placed in the back of the rack without requiring any rack U space.

NOTE: The use of the PDU Pivot Kit is strongly recommended and is the default option when orders are configured, as it will save 2U of valuable rack space.

NOTE: OD1 will appear after this part number to indicate factory integration where appropriate.

Performance Optimized Data Centers HP 3PAR StoreServ 7000 Storage is qualified for use in HP Performance Optimized Data Centers. Go to www.hp.com/go/POD for more information.

Non-HP rack and power requirements The Storage Bases, the Upgrade Node Pair, and the Drive Enclosures include mounting rails that are compatible with industry standard 4-post EIA 19 inch racks with square mounting holes. For detailed information on determining compatibility of a non-HP rack, please review the information included in the HP 3PAR StoreServ 7000 StoreServ 7000 Site Planning Guide

Expansion Options

HP provides a variety of SAS cable kits to allow expansion of the HP3PAR StoreServ 7000. Note that the Storage Base products, the Upgrade Node Pair and the Drive Enclosures all include SAS cables. Most configurations will not require a SAS expansion cable kit.

SAS expansion cable kit HP 6 Meter Expansion Cable Kit AP879A

If an HP 3PAR StoreServ 7000 needs to be expanded into an adjacent rack, one 6 meter SAS expansion cable kit is required for every node pair that must access drive enclosures in the expansion rack. Each 6 meter SAS expansion cable kit contains four 6 meter SAS cables.

HP 2 Meter Expansion Cable Kit AW566A

If an HP 3PAR StoreServ 7000 needs to be expanded within the same rack, but the new drive enclosure must be located some distance from the nearest existing drive enclosure within the same rack, one or two 2 meter SAS expansion cable kits is needed, depending on configuration. Each 2 meter SAS expansion cable kit contains two 2 meter SAS cables.

HP 1 Meter SAS Expansion Cable Kit QR514A

The 1 meter SAS expansion cable kit is provided for cases where a shorter SAS cable is required. Each 1 meter SAS expansion cable kit contains two 1 meter SAS cables.

NOTE: The 2-node Storage Bases and Upgrade Node Pair come with four 2 meter SAS cables each and the 4-node Storage Base comes with eight 2 meter SAS cables. The Drive Enclosures come with two 1 meter SAS cables each.

Step 8 - Choose Software

HP provides an extensive selection of features for HP 3PAR StoreServ Storage. All of the features available on the HP 3PAR StoreServ 10000 Storage system are also available on the HP 3PAR StoreServ 7000 Storage system, the result of a common architecture that spans from small and medium businesses to the largest global enterprise. For convenient ordering, the 3PAR StoreServ 7000 provides the features in Suites.

Two types of software licensing methods are employed with the HP 3PAR StoreServ 7000. Some software titles are licensed per system; other titles are licensed by drive. With system-based licensing one license covers the whole array, independent of configuration or capacity. Drive-based licensing, in contrast, is licensed per installed drive. A software title with drive-based licensing includes two Licenses to Use (LTU), a Base LTU that enables the software feature for the system and a Drive LTU that

Configuration Information

licenses the use of one drive. For each software title, purchase one Base LTU per title per array, and one Drive LTU, up to a cap, for every drive, that is installed in the array, independent of drive type. For the HP 3PAR StoreServ 7200 the Drive LTUs cap at 48. For the HP 3PAR StoreServ 7400 the Drive LTUs cap at 168. For the HP 3PAR StoreServ 7440c the Drive LTUs cap at 320. After reaching the cap, you do not need to purchase any more Drive LTUs for that title.

NOTE: All the HP 3PAR 7200 Software LTU are valid for both the HP 3PAR StoreServ 7200 and HP 3PAR StoreServ 7200c Storage systems, all the HP 3PAR 7400 Software LTU are valid for both the HP 3PAR StoreServ 7400 and HP 3PAR StoreServ 7400c Storage systems. The HP 3PAR 7440c Software LTU are valid only for the HP 3PAR StoreServ 7440c Storage system.

For more information regarding HP 3PAR software see <http://h18006.www1.hp.com/storage/solutions/3par/software.html>.

HP 3PAR 7000 Operating System Software Suite (Required)

HP 3PAR OS SW Suite - 3PAR Operating System, System Setup, and Management Software HP 3PAR 7000 Operating System Software Suite is the foundation software of HP 3PAR StoreServ 7000 Storage, combining advanced virtualization capabilities with simple storage management, high efficiency, and world class performance. The included comprehensive thin provisioning capabilities allow your storage to start thin, get thin and stay thin. System Tuner and Autonomic Rebalance help maintain high performance over time. Migrating your existing data from HP EVA, EMC CX4 or EMC VNX Storage and 3PAR systems to HP 3PAR StoreServ 7000 is easy with the included 180 day Online Import license. HP 3PAR SmartStart Software, included in the suite, guides you through the configuration of the service processor, HP 3PAR StoreServ Storage and the application hosts - making storage setup quick and easy. HP 3PAR 7000 Operating System Software Suite is a required purchase. It uses drive-based licensing. For more information see <http://h18006.www1.hp.com/storage/software/3par7000/oss/index.html>.

HP 3PAR 7200 Operating System Software Suite Base LTU	BC745B
HP 3PAR 7200 Operating System Software Suite Base E-LTU	BC745BAE
HP 3PAR 7200 Operating System Software Suite Drive LTU	BC746A
HP 3PAR 7200 Operating System Software Suite Drive E-LTU	BC746AAE
HP 3PAR 7400 Operating System Software Suite Base LTU	BC773B
HP 3PAR 7400 Operating System Software Suite Base E-LTU	BC773BAE
HP 3PAR 7400 Operating System Software Suite Drive LTU	BC774A
HP 3PAR 7400 Operating System Software Suite Drive E-LTU	BC774AAE
HP 3PAR 7440c Operating System Suite Base LTU	BD374A
HP 3PAR 7440c Operating System Suite Base E-LTU	BD374AAE
HP 3PAR 7440c Operating System Suite Drive LTU	BD381A
HP 3PAR 7440c Operating System Suite Drive E-LTU	BD381AAE

HP 3PAR 7000 Replication Software Suite

HP 3PAR 7000 Replication Software Suite - Local Replication, Remote Replication and The HP 3PAR Replication Software Suite offers automatic replication, transparent failover and Point-in-Time (PIT) copies enabling seamless disaster recovery for critical data. These features provide an agile, efficient and simple solution to protect against the unpredictable. This suite is ideal for virtualized data centers demanding data availability and business continuity 24x7. HP 3PAR 7000 Replication Software Suite consists of HP 3PAR Remote Copy Software, HP 3PAR Peer Persistence Software and HP 3PAR Virtual Copy Software, which are also available separately. Replication Software Suite uses drive-based licensing. For more information see

Configuration Information

Transparent Failover <http://h18006.www1.hp.com/storage/software/3par7000/drs/index.html>.

Failover

NOTE: The Peer Persistence feature provides transparent failover in VMware cluster environments and requires the Remote Copy feature as a prerequisite.

HP 3PAR 7200 Replication Software Suite Base LTU	BC747A
HP 3PAR 7200 Replication Software Suite Base E-LTU	BC747AAE
HP 3PAR 7200 Replication Software Suite Drive LTU	BC748A
HP 3PAR 7200 Replication Software Suite Drive E-LTU	BC748AAE
HP 3PAR 7400 Replication Software Suite Base LTU	BC775A
HP 3PAR 7400 Replication Software Suite Base E-LTU	BC775AAE
HP 3PAR 7400 Replication Software Suite Drive LTU	BC776A
HP 3PAR 7400 Replication Software Suite Drive E-LTU	BC776AAE
HP 3PAR 7440c Replication Suite Base LTU	BD382A
HP 3PAR 7440c Replication Suite Base E-LTU	BD382AAE
HP 3PAR 7440c Replication Suite Drive LTU	BD383A
HP 3PAR 7440c Replication Suite Drive E-LTU	BD383AAE

NOTE: If the configuration includes Remote Copy over Fibre Channel it is recommended that optional Fiber Channel HBAs are purchased as the built in ports will not offer sufficient connectivity

HP 3PAR 7000 Security Software Suite

HP 3PAR 7000 Security Software Suite

HP 3PAR 7000 Security Software Suite provides secure administrative segregation of users and hosts, allowing individual user groups and applications to confidently share a 3PAR StoreServ 7000 system. It also allows you to secure volumes and copies so they cannot be deleted, even by a 3PAR StoreServ 7000 user with the highest level privileges. When coupled with reservation less, non-duplicative, read-only virtual copies (snapshots), the Virtual Lock feature enables you to retain frozen, point-in-time copies of your data to assist internal data retention and simplify compliance with internal governance procedures. HP 3PAR 7000 Security Software Suite consists of HP 3PAR Virtual Domains Software and HP 3PAR Virtual Lock Software, which are also available separately. Security Software Suite uses drive-based licensing. For more information see <http://h18006.www1.hp.com/storage/software/3par7000/ss/index.html>.

HP 3PAR 7200 Security Software Suite Base LTU	BC751A
HP 3PAR 7200 Security Software Suite Base E-LTU	BC751AAE
HP 3PAR 7200 Security Software Suite Drive LTU	BC752A
HP 3PAR 7200 Security Software Suite Drive E-LTU	BC752AAE
HP 3PAR 7400 Security Software Suite Base LTU	BC779A
HP 3PAR 7400 Security Software Suite Base E-LTU	BC779AAE
HP 3PAR 7400 Security Software Suite Drive LTU	BC780A
HP 3PAR 7400 Security Software Suite Drive E-LTU	BC780AAE
HP 3PAR 7440c Security Suite Base LTU	BD384A
HP 3PAR 7440c Security Suite Base E-LTU	BD384AAE
HP 3PAR 7440c Security Suite Drive LTU	BD385A
HP 3PAR 7440c Security Suite Drive E-LTU	BD385AAE

HP 3PAR 7000 Data Optimization Software Suite



Configuration Information

HP 3PAR 7000 Data Optimization Software Suite - Rebalance, Redistribute, and Refresh The HP 3PAR 7000 Data Optimization Software Suite makes sure that data is on the right storage asset at the right time. This suite rebalances, redistributes and refreshes storage non-disruptively with features that provide autonomic storage tiering and dynamic data mobility, reducing cost and increasing agility. HP 3PAR 7000 Data Optimization Software Suite consists of HP 3PAR Dynamic Optimization Software, HP 3PAR Adaptive Optimization Software and HP 3PAR Peer Motion Software (providing federation capability for data mobility), which are also available separately. Data Optimization Software Suite uses drive-based licensing. For more information see <http://h18006.www1.hp.com/storage/software/3par7000/dos/index.html>.

NOTE: The Adaptive Optimization feature requires HP 3PAR Reporting Software Suite as a prerequisite.

HP 3PAR 7200 Data Optimization Software Suite Base LTU	BC749A
HP 3PAR 7200 Data Optimization Software Suite Base E-LTU	BC749AAE
HP 3PAR 7200 Data Optimization Software Suite Drive LTU	BC750A
HP 3PAR 7200 Data Optimization Software Suite Drive E-LTU	BC750AAE
HP 3PAR 7400 Data Optimization Software Suite Base LTU	BC777A
HP 3PAR 7400 Data Optimization Software Suite Base E-LTU	BC777AAE
HP 3PAR 7400 Data Optimization Software Suite Drive LTU	BC778A
HP 3PAR 7400 Data Optimization Software Suite Drive E-LTU	BC778AAE

HP 3PAR 7000 Data Optimization Software Suite v2

Ensure Quality of Service with dynamic data mobility The HP 3PAR Data Optimization Software Suite v2 combines capabilities that provide autonomic storage tiering and dynamic data mobility with assured quality of service . Adaptive Optimization provides highly reliable, non-disruptive, cost-optimized storage tiering at the sub-volume level to deliver the right QoS to the right data at the right time on a large scale and Dynamic Optimization delivers it at the volume level. Peer Motion software enables seamless technology refresh and cost-optimized asset lifecycle management, and lowers technology refresh capital expenditure. Priority Optimization software allows customers to ensure quality of service on HP 3PAR StoreServ Storage Systems. With Priority Optimization, customers can guarantee service levels in multi-tenant environments

The Data Optimization Suite v2 bundles the following products:

- HP 3PAR Adaptive Optimization
- HP 3PAR Dynamic Optimization
- HP 3PAR Peer Motion
- HP 3PAR Priority Optimization

For more information see <http://h18006.www1.hp.com/storage/software/3par7000/dos/index.html>

Models	HP 3PAR 7200 Data Optimization Software Suite V2 Base LTU	BD268A
	HP 3PAR 7200 Data Optimization Software Suite V2 Base E-LTU	BD268AAE
	HP 3PAR 7200 Data Optimization Software Suite V2 Drive LTU	BD269A
	HP 3PAR 7200 Data Optimization Software Suite V2 Drive E-LTU	BD269AAE
	HP 3PAR 7400 Data Optimization Software Suite V2 Base LTU	BD270A
	HP 3PAR 7400 Data Optimization Software Suite V2 Base E-LTU	BD270AAE

Configuration Information

HP 3PAR 7400 Data Optimization Software Suite V2 Drive LTU	BD271A
HP 3PAR 7400 Data Optimization Software Suite V2 Drive E-LTU	BD271AAE
HP 3PAR 7440c Data Optimization Suite v2 Base LTU	BD404A
HP 3PAR 7440c Data Optimization Suite v2 Base E-LTU	BD404AAE
HP 3PAR 7440c Data Optimization Suite v2 Drive LTU	BD405A
HP 3PAR 7440c Data Optimization Suite v2 Drive E-LTU	BD405AAE

HP 3PAR File Persona Software Suite

HP 3PAR File Persona Software Suite – Converged Block, File and Object Access The HP 3PAR File Persona Software Suite is a licensed feature of the 3PAR OS that enables a rich set of file protocols and core file data services on a 3PAR StoreServ system. As a feature of the 3PAR OS, the File Persona inherits the industry leading architecture and Block Persona benefits of 3PAR StoreServ. It extends the spectrum of primary storage workloads natively addressed by 3PAR StoreServ from virtualization, databases, and applications via the Block Persona to also include client workloads such as home directory consolidation, group/department shares, and corporate shares via the File Persona – all with truly Converged Controllers, truly agile capacity, and truly unified management.

The File Persona is supported on the 3PAR StoreServ 7200c, 7400c, and 7440c. It requires the installation of 1GbE (E7X97A) or 10GbE (E7X96A) network cards.

For more information see <http://www.hp.com/go/3PAR/FilePersona>

NOTE: The File Persona feature requires HP 3PAR 7000 Operating System Software Suite as a prerequisite.

Models The HP 3PAR File Persona Software Suite is currently available via Controlled Release for production deployment in select countries. Please contact your HP representative for more information.

HP 3PAR Reporting Software Suite

HP 3PAR Reporting Software Suite - Historical Performance and Capacity Management Tool The HP 3PAR Reporting Software Suite includes System Reporter, a historical performance and capacity management tool for storage reporting, monitoring, and troubleshooting. Also included is 3PARInfo, a command line tool that allows you to view HP 3PAR StoreServ Storage configuration information. Reporting Software Suite uses system-based licensing. For more information see <http://h18006.www1.hp.com/storage/software/3par7000/rs/index.html>.

HP 3PAR 7200 Reporting Suite LTU	BC767B
HP 3PAR 7200 Reporting Suite E-LTU	BC767BAE
HP 3PAR 7400 Reporting Suite LTU	BC795B
HP 3PAR 7400 Reporting Suite E-LTU	BC795BAE
HP 3PAR 7440c Reporting Suite LTU	BD375A
HP 3PAR 7440c Reporting Suite E-LTU	BD375AAE

Configuration Information

HP 3PAR Application Software Suite for Oracle

HP 3PAR Application Software Suite for Oracle - Application Protection The HP 3PAR Application Software Suite for Oracle provides everything you need for protecting Oracle databases, including Recovery Manager for Oracle and Oracle Space Reclamation capabilities. Recovery Manager for Oracle is an extension to 3PAR Virtual Copy that intelligently creates, manages, and presents time-consistent snapshot images of Oracle® databases for rapid application recovery, near-continuous data protection, data sharing, and non-disruptive backup. Application Software Suite for Oracle uses system-based licensing. For more information see <http://h18006.www1.hp.com/storage/software/3par7000/as-oracle/index.html>.

NOTE: HP 3PAR Virtual Copy Software is a prerequisite, purchased independently or in the HP 3PAR Replication Software Suite.

HP 3PAR 7200 Application Suite for Oracle LTU	BC771B
HP 3PAR 7200 Application Suite for Oracle E-LTU	BC771BAE
HP 3PAR 7400 Application Suite for Oracle LTU	BC799B
HP 3PAR 7400 Application Suite for Oracle E-LTU	BC799BAE
HP 3PAR 7440c Application Suite for Oracle LTU	BD379A
HP 3PAR 7440c Application Suite for Oracle E-LTU	BD379AAE

HP 3PAR Application Software Suite for SQL

HP 3PAR Application Software Suite for SQL - Application Protection The HP 3PAR Application Software Suite for SQL protects Microsoft® SQL databases with Recovery Manager for Microsoft® SQL and the 3PAR VSS Provider software. 3PAR Recovery Manager for Microsoft® SQL Server is an extension to 3PAR Virtual Copy that eases costs and administration by providing rapid, affordable online recovery of Microsoft® SQL Server databases from multiple, highly granular point-in-time snapshots. Quickly recover a database to a known point in time, speeding up a variety of operations including rapid recovery of the production SQL server. Application Software Suite for SQL uses system-based licensing. For more information see <http://h18006.www1.hp.com/storage/software/3par7000/as-sql/index.html>.

NOTE: HP 3PAR Virtual Copy Software is a prerequisite, purchased independently or in the HP 3PAR Replication Software Suite.

HP 3PAR 7200 Application Suite for Microsoft SQL LTU	BC770B
HP 3PAR 7200 Application Suite for Microsoft SQL E-LTU	BC770BAE
HP 3PAR 7400 Application Suite for Microsoft SQL LTU	BC798B
HP 3PAR 7400 Application Suite for Microsoft SQL E-LTU	BC798BAE
HP 3PAR 7440c Application Suite for SQL LTU	BD378A
HP 3PAR 7440c Application Suite for SQL E-LTU	BD378AAE

HP 3PAR Application Software Suite for Exchange

HP 3PAR Application Software Suite for Exchange - Application Protection The HP 3PAR Application Software Suite for Exchange provides you the essentials for protecting your Microsoft Exchange data, including Recovery Manager for Exchange and the VSS Provider software. Recovery Manager for Exchange is an extension to 3PAR Virtual Copy that intelligently creates and manages snapshots that can be used to quickly restore Exchange instances or databases (or non-disruptively back them up to tape) for near-continuous data protection. Application Software Suite for Exchange uses system-based licensing. For more information see

Configuration Information

<http://h18006.www1.hp.com/storage/software/3par7000/as-exchange/index.html>.

NOTE: HP 3PAR Virtual Copy Software is a prerequisite, purchased independently or in the HP 3PAR Replication Software Suite.

HP 3PAR 7200 Application Suite for Microsoft Exchange LTU	BC769B
HP 3PAR 7200 Application Suite for Microsoft Exchange E-LTU	BC769BAE
HP 3PAR 7400 Application Suite for Microsoft Exchange LTU	BC797B
HP 3PAR 7400 Application Suite for Microsoft Exchange E-LTU	BC797BAE
HP 3PAR 7440c Application Suite for Exchange LTU	BD377A
HP 3PAR 7440c Application Suite for Exchange E-LTU	BD377AAE

HP 3PAR Application Software Suite for Microsoft Hyper-V

HP 3PAR Application Software Suite for Hyper-V - Application Protection

The HP 3PAR Application Software Suite for Hyper-V provides you the essentials for protecting your Microsoft Hyper-V environment, including Recovery Manager for Hyper-V and the VSS Provider software. Recovery Manager for Hyper-V is an extension to 3PAR Virtual Copy that intelligently creates and manages snapshots that can be used to quickly restore Hyper-V VMs for near-continuous data protection. Application Software Suite for Hyper-V uses system-based licensing.

NOTE: HP 3PAR Virtual Copy Software is a prerequisite, purchased independently or in the HP 3PAR Replication Software Suite.

HP 3PAR 7200 Application Suite for Microsoft Hyper-V LTU	BD178B
HP 3PAR 7400 Application Suite for Microsoft Hyper-V LTU	BD179B
HP 3PAR 7200 Application Suite for Microsoft Hyper-V E-LTU	BD178BAE
HP 3PAR 7400 Application Suite for Microsoft Hyper-V E-LTU	BD179BAE
HP 3PAR 7440c Application Suite for Hyper-V LTU	BD380A
HP 3PAR 7440c Application Suite for Hyper-V E-LTU	BD380AAE

HP 3PAR Application Software Suite for VMware

HP 3PAR Application Software Suite for VMware - Application Protection

The HP 3PAR Application Software Suite for VMware provides everything you need to make your VMware environment more agile and efficient—including Recovery Manager for VMware, Host Explorer for VMware, VASA support, and three essential plug-ins: the VMware Site Replication Manager (SRM) Adapter, the 3PAR VAAI plug-in, and the 3PAR management plug-in for VMware View. Application Software Suite for VMware uses system-based licensing. For more information see <http://h18006.www1.hp.com/storage/software/3par7000/as-vmware/index.html>.

NOTE: HP 3PAR Virtual Copy Software is a prerequisite, purchased independently or in the HP 3PAR Replication Software Suite.

HP 3PAR 7200 Application Suite for VMware LTU	BC768B
HP 3PAR 7200 Application Suite for VMware E-LTU	BC768BAE
HP 3PAR 7400 Application Suite for VMware LTU	BC796B
HP 3PAR 7400 Application Suite for VMware E-LTU	BC796BAE
HP 3PAR 7440c Application Suite for VMware LTU	BD376A
HP 3PAR 7440c Application Suite for VMware E-LTU	BD376AAE

Configuration Information

HP Cluster Extension Software

HP Cluster Extension Software- High Availability HP Cluster Extension Software (CLX) offers protection against application downtime from fault, failure, or site disaster by extending a local cluster between data centers over metropolitan distance. CLX reinstates critical applications at a remote site within minutes or seconds after an adverse event. CLX integrates with the OS clustering software (such as MS Cluster Service in Windows) and the remote mirroring software on storage (such as HP Continuous Access software on P6000 EVA/P9000 and HP 3PAR Remote Copy Software on HP 3PAR systems) to automate failover and failback between sites. This dual integration enables the cluster service to verify the status of the storage as well as the server cluster; thus allowing the correct failover and failback decisions to be made which minimize downtime, and accelerates recovery without human intervention. Thus the Cluster Extension Software can help customers achieve 'zero' RPO and RTO in minutes or seconds. For more information, including how Cluster Extension Software is licensed, see <http://h18006.www1.hp.com/storage/software/ces/index.html>.

Step 9 - Choose Options for Storage Networking

HP's comprehensive portfolio of Storage Area Network infrastructure products and solutions are designed to meet a range of storage networking needs from small and mid-sized businesses to the largest corporate enterprises. HP StoreFabric storage networking SAN Solutions deliver scalability, performance, and broad interoperability required for critical data and applications.

For additional details on SAN infrastructure components and options and storage compatibility information, please visit: <http://hp.com/go/san> or select from the part numbers below.

Fibre Channel Host Bus Adapters	Brocade Fibre Channel HBAs		
	HP 81B 8Gb 1-port PCIe Fibre Channel Host Bus Adapter	AP769B	
	HP 82B 8Gb 2-port PCIe Fibre Channel Host Bus Adapter	AP770B	
	Emulex Fibre Channel HBAs		
	HP 81E 8Gb 1-port PCIe Fibre Channel Host Bus Adapter	AJ762B	
	HP 82E 8Gb 2-port PCIe Fibre Channel Host Bus Adapter	AJ763B	
	QLogic Fibre Channel HBAs		
	HP 81Q 8Gb 1-port PCIe Fibre Channel Host Bus Adapter	AK344A	
	HP 82Q 8Gb 2-port PCIe Fibre Channel Host Bus Adapter	AJ764A	
	Fibre Channel Switches	HP B-series	
		8 Gb Fibre Channel Switches	
		HP 8/8 Base (0) e-port SAN Switch	AM866B
HP 8/8 (8) Full Fabric Ports Enabled SAN Switch		AM867B	
HP 8/24 Base (16) Full Fabric Ports Enabled SAN Switch		AM868B	
16 Gb Fibre Channel Switches			
HP SN3000B 16Gb 24-port/12-port Active Fibre Channel Switch		QW937A	
HP SN3000B 16Gb 24-port/24-port Active Fibre Channel Switch		QW938A	
HP SN6000B 16Gb 48-port/24-port Active Fibre Channel Switch		QK753B	
HP SN6000B 16Gb 48-port/48-port Active Fibre Channel Switch		QR480B	
HP SN6000B 16Gb 48-port/24-port Active Power Pack+ Fibre Channel Switch		QK754B	
HP SN6000B 16Gb 48-port/48-port Active Power Pack+ Fibre Channel Switch		QR481B	
HP StoreFabric SN6500B 16Gb 96/96 Power Pack+ FC Switch	C8R42A		

Configuration Information

HP StoreFabric SN6500B 16Gb 96/96 FC Switch	C8R43A
HP StoreFabric SN6500B 16Gb 96/48 Power Pack+ FC Switch	C8R44A
HP StoreFabric SN6500B 16Gb 96/48 FC Switch	C8R45A

FCoE, Extension and Embedded Switches

HP 1606 FCIP 16-pt Enabled 8Gb FC 6-pt Enabled 1GbE Full Switch	AP863B
HP 1606 FCIP 4-pt Enabled 8Gb FC 2-pt Enabled 1GbE Base Switch	AP862B
HP 1606 FCIP 16-pt Enabled 8Gb FC 6-pt Enabled 1GbE Power Pack+ Switch	AP864B
Brocade 16Gb/16 SAN Switch for BladeSystem c-Class	C8S45A
Brocade 16Gb/28 SAN Switch for BladeSystem c-Class	C8S46A
Brocade 16Gb/28 SAN Switch Power Pack+ for BladeSystem c-Class	C8S47A
Brocade 8/12c SAN Switch for BladeSystem c-Class	AJ820B
Brocade 8/24c SAN Switch for BladeSystem c-Class	AJ821B
Brocade 8/24c Power Pack+ SAN Switch for BladeSystem c-Class	AJ822B

HP H-series

HP 8/20q Fibre Channel 8-ports Active Switch	AQ233B
NOTE: 8 device ports active, upgradeable to 20 device ports active	
HP 8Gb Simple SAN Connection Kit	AK241B
NOTE: 8 device ports active, upgradeable to 20 device ports active	
HP 8/20q Fibre Channel Switch	AK242B
NOTE: 16 switch ports active, upgradeable to 20 device ports active	
HP SN6000 Stackable 8Gb 24-port Single Power Fibre Channel Switch	AW575B
NOTE: 20 device ports active/4 stacking (ISL) ports active	
HP SN6000 Stackable 8Gb 24-port Dual Power Fibre Channel Switch	AW576B
NOTE: 20 device ports active/4 stacking (ISL) ports active	
HP SN6000 Stackable 12-port Single Power FC Switch	BK780B
NOTE: 8 device ports/4 stacking (ISL) ports active, upgradeable to 20 device ports active	

HP C-series

HP SN8000C 13-Slot Supervisor 2A Fabric 3 Director Switch	QW927A
HP SN6000C 8Gb 16-port Fibre Channel Switch	AW585A
HP SN6000C 8Gb 32-port Fibre Channel Switch	AW586A
Cisco MDS 8/12c Fabric Switch for HP BladeSystem c-Class	AW563A
Cisco MDS 8/24c Fabric Switch for HP BladeSystem c-Class	AW564A
Cisco MDS 9124 8-ports Active Fabric Switch	AG646A
Cisco MDS 9124 16-ports Active Fabric Switch	AG647A
Cisco MDS 9222i Multiservice with 0 SFP Transceiver Modular Fabric Switch	AG851B

HP Intelligent Infrastructure Analyzer Software (IIAS)

HP Intelligent Infrastructure Analyzer Software v2 LTU	TC472A
HP Intelligent Infrastructure Analyzer Software v2 E-LTU	TC472AAE

An online monitoring and diagnostic solution intended to manage the physical layer of a Storage Area Network (SAN) consisting of HP B-series and/or H-series Fibre Channel switches and directors. It uses industry-standard protocols (such as SNMP, SMI-S, Telnet) to monitor the physical layer across the SAN and to

Configuration Information

diagnose changes/events in Small Form-factor Pluggable (SFP) transceiver states/characteristics. It also presents the SAN topology, inventory and diagnostic information to the user in real-time.

HP Virtual Connect

HP 3PAR StoreServ 7000 Storage supports direct attach with HP Virtual Connect FlexFabric. Please refer to SPOCK for HP Virtual Connect information.

<http://h20272.www2.hp.com/index.aspx>

PremierFlexOM4 cable options	HP Premier Flex LC/LC Multi-mode OM4 2 fiber 1m Cable	QK732A
	HP Premier Flex LC/LC Multi-mode OM4 2 fiber 2m Cable	QK733A
	HP Premier Flex LC/LC Multi-mode OM4 2 fiber 5m Cable	QK734A
	HP Premier Flex LC/LC Multi-mode OM4 2 fiber 15m Cable	QK735A
	HP Premier Flex LC/LC Multi-mode OM4 2 fiber 30m Cable	QK736A
	HP Premier Flex LC/LC Multi-mode OM4 2 fiber 50m Cable	QK737A
OM3 FC LC-LC cables options	HP LC to LC Multi-mode OM3 2-Fiber 0.5m 1-Pack Fiber Optic Cable	AJ833A
	HP LC to LC Multi-mode OM3 2-Fiber 1.0m 1-Pack Fiber Optic Cable	AJ834A
	HP LC to LC Multi-mode OM3 2-Fiber 2.0m 1-Pack Fiber Optic Cable	AJ835A
	HP LC to LC Multi-mode OM3 2-Fiber 5.0m 1-Pack Fiber Optic Cable	AJ836A
	HP LC to LC Multi-mode OM3 2-Fiber 15.0m 1-Pack Fiber Optic Cable	AJ837A
	HP LC to LC Multi-mode OM3 2-Fiber 30.0m 1-Pack Fiber Optic Cable	AJ838A
	HP LC to LC Multi-mode OM3 2-Fiber 50.0m 1-Pack Fiber Optic Cable	AJ839A

Step 10 - Federation / Data Migration

HP provides several ways to migrate your data from older arrays. Peer Motion provides federation with other 3PAR arrays, which includes the ability to migrate data to HP 3PAR StoreServ 7000 Storage (Peer Motion is part of the HP 3PAR 7000 Data Optimization Software Suite). Peer Motion Software is also available as a standalone license.

HP 3PAR Peer Motion Software

HP 3PAR 7200 Peer Motion Software Base LTU	BC761A
HP 3PAR 7200 Peer Motion Software Drive LTU	BC762A
HP 3PAR 7400 Peer Motion Software Base LTU	BC789A
HP 3PAR 7400 Peer Motion Software Drive LTU	BC790A
HP 3PAR 7440c Peer Motion Base LTU	BD394A
HP 3PAR 7440c Peer Motion Base E-LTU	BD394AAE
HP 3PAR 7440c Peer Motion Drive LTU	BD395A
HP 3PAR 7440c Peer Motion Drive E-LTU	BD395AAE

* Insert AE at the end of a part number for an electronic LTU (eg. XXXXBAE). E-Delivery should be ordered with any Standalone or Upgrade software order.

Online Import allows you to easily migrate data from HP EVA, EMC CX4 or EMC VNX Storage arrays to the HP 3PAR StoreServ 7000, a 180-day Online Import license is built into the HP 3PAR 7000 Operating System Software Suite. Additional licenses are available to order.

HP 3PAR Online Import Software

HP 3PAR 7200 Online Import Software 180 day LTU	BD191A
HP 3PAR 7400 Online Import Software 180 day LTU	BD192A
HP 3PAR 7440c Online Import 180-day LTU	BD407A
HP 3PAR 7440c Online Import 180-day E-LTU	BD407AAE

Configuration Information

* Insert AE at the end of a part number for an electronic LTU (eg. XXXXBAE). E-Delivery should be ordered with any Standalone or Upgrade software order.

In addition HP supports the MPX200.

HP MPX200 Multi-protocol and Heterogeneous Data Migration

The HP MPX200 Multiprotocol Router provides support for HP 3PAR StoreServ 7000 and 10000 as well as 3PAR F/T, including 1GbE iSCSI and 10GbE iSCSI and FCoE target support. MPX200 iSCSI provides an alternative option for HP 3PAR storage systems if you don't want to dedicate native iSCSI ports on your array. The MPX200 also facilitates the sharing of iSCSI/FCoE connectivity simultaneously for HP 3PAR storage systems from the same MPX200. For Data Migration the MPX200 provides high performance migration from P6000/EVA to HP 3PAR storage systems and simplifies Data Migration from third party storage such as IBM and EMC to HP 3PAR. The MPX200 is an ideal solution enabler for HP 3PAR customers. <http://www.hp.com/go/mpx200>

MPX200 Multifunction Router	HP MPX200 1GbE Base Multifunction Router	AP771B
	HP MPX200 Multifunction Router 1GbE Upgrade Blade	AP772B
	HP MPX200 10-1GbE Base Multifunction Router	AP773B
	HP MPX200 Multifunction Router 10-1GbE Upgrade Blade	AP774B
FCIP Software	HP MPX200 Half Chassis FCIP License	TA766A
	HP MPX200 Full Chassis FCIP License	TA767A
Data Migration Software	HP MPX200 1TB Full Chassis Data Migration License	TA762A
	HP MPX200 5TB Full Chassis Data Migration License	TA763A
	HP MPX200 Full Chassis 1 Array Data Migration License	TA764A

Step 11 - File Controller (For detailed specifications, please refer to File Controller v1 or v2 section)

These models come with factory-installed drives and the Microsoft Windows Storage Server 2012 Standard Edition or Windows Storage Server 2012 R2 Standard Edition operating system pre-installed

Choose a Pre-configured Model

HP 3PAR StoreServ File Controller		Part Number
		E7X02A
Specifications	Operating System	Microsoft Windows Storage Server 2012 R2, Standard
	Processor	Intel® Xeon® E5-2609v2 (2.50GHz/4-core/10MB/80W) Processor
	Memory	16 GB (4 x 4GB)
	Storage Controller	Smart Array P420i with 1 GB FBWC Controller with internal SAS port for O/S drives)
	Internal Storage	2 x 300GB 6G SAS 10K 2.5" ENT hot-plug SFF HDDs (O/S mirror)
	Expansion Slots	3 x PCIe (6 with option PCIe Riser)
	Network Ports	4 x 1GbE
	Form Factor	2U Rack

Configuration Information

		Part Number
HP 3PAR StoreServ File Controller		C8569A
Specifications	Operating System	Microsoft Windows Storage Server 2012, Standard
	Processor	Intel® Xeon® E5-2609 (2.40GHz/4-core/10MB/80W) Processor
	Memory	16 GB (4 x 4GB)
	Storage Controller	Smart Array P420i with 1 GB FBWC Controller with internal SAS port for O/S drives)
	Internal Storage	2 x 450GB 6G SAS 10K 2.5" ENT hot-plug SFF HDDs (O/S mirror)
	Expansion Slots	3 x PCIe (6 with option PCIe Riser)
	Network Ports	4 x 1GbE
	Form Factor	2U Rack

Add a second processor

Intel® Xeon® E5-2609v2 (2.5GHz/4-core/10MB/80W) Processor Kit	715222-B21
NOTE: For E7X02A only	
Intel® Xeon® E5-2609 (2.40GHz/4-core/10MB/80W) Processor Kit	662252-B21
NOTE: For C8569A only	

Add More Memory

NOTE: HP recommends that you add the same type memory to the product that is shipped standard with the product.

NOTE: HP memory from previous generation servers are not fully compatible with Smart Memory features in Gen8 Servers.

Registered DIMMs (RDIMMs)

HP 4GB (1x4GB) Single Rank x4 PC3L-12800R (DDR3-1600) Registered CAS-11 Low Voltage Memory Kit	713981-B21
NOTE: For E7X02A only	
HP 4GB (1x4GB) Single Rank x4 PC3L-10600R (DDR3-1333) Registered CAS-9 Low Voltage Memory Kit	647893-B21
NOTE: For C8569A only	

NOTE: All DDR3 memory option kits consist of one DIMM per kit. For detailed memory configuration rules and guidelines, please use the Online DDR3 Memory Configuration Tool: www.hp.com/go/ddr3memory-configurator.

NOTE: PC3L is a low voltage memory.

See the HP ProLiant Gen 8 QuickSpecs for information on memory configurations.
http://h18004.www1.hp.com/products/quickspecs/14212_div/14212_div.html

Add 3PAR StoreServ File Controller v2 Performance Kit

HP 3PAR StoreServ File Controller 1Gb Performance Kit	E7X04A
NOTE: This kit adds the second Intel® Xeon® E5-2609v2 Processor, an additional 16GB (4 x 4GB)	

Configuration Information

of Memory, and a 1GbE 4 port NC365T Adapter to the 3PAR File Controller v2

HP 3PAR StoreServ File Controller 10Gb Performance Kit

E7X05A

NOTE: This kit adds the second Intel® Xeon® E5-2609v2 Processor, an additional 16GB (4 x 4GB)

of Memory, and a 10GbE 2 port 560SFP+ Adapter to the 3PAR File Controller v2

Add additional options

NOTE: Multifunction Server Adapters support the installed Microsoft Windows Server Scalable Networking Pack, which enables TCP Chimney offload, Receive-side Scaling (RSS), and Network Direct Memory Access (NetDMA) features.

HP Networking

Gigabit Ethernet adapters

HP NC112T PCI Express Gigabit Server Adapter 503746-B21

HP NC365T 4-port Ethernet Server Adapter 593722-B21

HP Ethernet 1Gb 4-port 331T Adapter 647594-B21

HP Ethernet 1Gb 2-port 361T Adapter 652497-B21

HP Ethernet 1Gb 2-port 332T Adapter 615732-B21

10 Gigabit Ethernet Adapters

NOTE: A minimum of two Gigabytes (2 GB) of server memory is required per each adapter.

NOTE: Direct Attach Cable (DAC) for copper environments or fiber transceivers and cables for fiber-optic environments must be purchased separately.

HP NC523SFP 10Gb 2-port Server Adapter 593717-B21

HP Ethernet 10Gb 2-port 530SFP Adapter 652503-B21

HP Ethernet 10Gb 2-port 530T Adapter 656596-B21

HP Ethernet 10Gb 2-port 560SFP+ Adapter 665249-B21

HP NC552SFP 10Gb 2-port Ethernet Server Adapter 614203-B21

HP Infiniband

QLogic InfiniBand 4X QDR PCI-E G2 Dual Port HCA 583211-B21

HP InfiniBand 4X QDR ConnectX-2 PCIe G2 Dual Port HCA 592520-B21

NOTE: For the following two InfiniBand Adapters, only 1 FlexibleLOM can be added to the server, which is selected in Step 2 for the "Configuration Information - Factory Integrated Models" section. These two options are for upgrade or change from original configuration.

NOTE: FLR Indicates new HP FlexibleLOM Adapter series.

HP Infiniband FDR/Ethernet 10Gb/40Gb 2-port 544FLR-QSFP Adapter 649282-B21

HP Infiniband QDR/Ethernet 10Gb 2-port 544FLR-QSFP Adapter 649283-B21

HP InfiniBand FDR 2-port 545QSFP Adapter 702211-B21

NOTE: 10Gb Ethernet requires the use of the QSFP to SFP+ adapter P/N 655874-B21.

NOTE: Please see the QuickSpecs for additional information:

http://h18000.www1.hp.com/products/quickspecs/13078_div/13078_div.html

HP Optical Drives

HP 12.7mm Slim SATA DVD-ROM JackBlack Optical Drive 652232-B21

HP 12.7mm Slim SATA DVD-RW JackBlack Optical Drive 652235-B21

HP I/O Expansion Options

HP DL380p/385p/560 Gen8 3 Slot PCI-E Riser Kit 653206-B21

NOTE: When populating the second optional riser slot, the second processor must be installed.

HP Security

HP Trusted Platform Module Option 488069-B21

NOTE: The TPM (Trusted Platform Module) is a microcontroller chip that can securely store artifacts used to authenticate the server platform. These artifacts can include passwords, certificates and encryption keys. Windows® BitLocker™ Drive Encryption (BitLocker) is a data

Configuration Information

protection feature available in Windows Server® 2008. BitLocker leverages the enhanced security capabilities of a Trusted Platform Module (TPM) version 1.2. The TPM works with BitLocker to help protect user data and to ensure that a server running Windows Server 2008 has not been tampered with while the system was offline. For more information about TPM, including a white paper, go to: www.hp.com/go/TPM.

NOTE: The TPM key is unique to every TPM deployed server and must be retained. Misplacing or losing the key could result in data loss.

HP 3PAR StoreServ File Controller is designed and optimized for connection to 3PAR StoreServ Storage and uses HBAs, rather than additional Storage Controllers.

NOTE: HBAs are not included standard. HBA selection is left as your choice based on existing SAN infrastructure.

HP Fibre Channel Storage Fibre Channel HBA

NOTE: For the complete listing of Fibre Channel Host Bus Adapters for Windows 2000, Windows Server 2003 and Linux, please see:

<http://h18006.www1.hp.com/storage/saninfrastructure/hba.html>

Brocade Fibre Channel HBAs

HP 82B 8Gb 2-port PCIe Fibre Channel Host Bus Adapter AP770B

Emulex Fibre Channel HBAs

HP 82E 8Gb 2-port PCIe Fibre Channel Host Bus Adapter AJ763B

HP SN1000E 16Gb 2-port PCIe Fibre Channel Host Bus Adapter QR559A

HP StoreFabric SN1100E 16Gb Dual Port Fibre Channel Host Bus Adapter C8R39A

QLogic Fibre Channel HBAs

HP 82Q 8Gb 2-port PCIe Fibre Channel Host Bus Adapter AJ764A

HP StoreFabric SN1000Q 16GB 2-port PCIe Fibre Channel Host Bus Adapter QW972A

Converged Network Adapter

HP CN1100E Dual Port Converged Network Adapter BK835A

HP CN1000Q Dual Port Converged Network Adapter BS668A

HP StoreFabric CN1100R Dual Port Converged Network Adapter QW990A

WSS2012 R2 Upgrade WSS2012 R2 Standard Edition Upgrade Kit

HP 3PAR StoreServ File Controller products with the Microsoft Windows Storage Server 2012, Standard Edition Operating System are eligible for a Software-Only Pay-for-Upgrade to the Microsoft Windows Storage Server 2012 R2.

* A minimum of two OS drives that are the same type and capacity (146GB minimum) must be present in the system before installation.

NOTE: Some expansion cards, including HBAs and NICs, may not be supported by Windows Storage Server 2012 R2. Check Windows Server 2012 R2 driver availability before purchase and installation. All original components that were standard on the 3PAR StoreServ File Controller are supported.

NOTE: Check for HP and 3rd-party software qualification with the Windows Storage Server 2012 R2 operating system before purchase and installation.

HP StoreEasy WSS2012 R2 Standard Edition Upgrade Kit

D4T73A

Configuration Information

Add a Power Cord

The HP 3Par StoreServ File Controller comes standard with at least one rack (IEC-IEC) PDU power cord. If you wish to use wall outlet power instead, you can choose a country- or region-specific power cord.

3Par StoreServ File Controller	HP C13 - Nema 5-15P US/CA 110V 10Amp 1.83m Power Cord	AF556A
	HP C13 - GB-1002 CN 250V 10Amp 1.83m Power Cord	AF557A
	HP C13 - IRAM -2073 AR 250V 10A 2.5m Power Cord	AF558A
	HP C13 - Nema 5-15P TH/PH 250V 10Amp 1.83m Power Cord	AF559A
	HP C13 - KSC- 8305 KR 250V 10Amp 1.83m Power Cord	AF560A
	HP C13 - CNS-690 TW 110V 13Amp 1.83m Power Cord	AF561A
	HP C13 - IS-1293 IN 240V 6Amp LV 2.0m Power Cord	AF562A
	HP C13 - AS3112-3 AU 250V 10Amp 2.5m Power Cord	AF569A
	HP C13 - SEV 1011 CH 250V 10Amp 1.83m Power Cord	AF565A
	HP C13 - DK-2.5A DK 250V 10Amp 1.83m Power Cord	AF566A
	HP C13 - CEE-VII EU 250V 10Amp 1.83m Power Cord	AF568A
	HP C13 - SI-32 IL 250V 10Amp 1.83m Power Cord	AF564A
	HP C13 - CEI-23-50 IT/CL 250V 10Amp 1.83m Power Cord	AF571A
	HP C13 - JIS C8303 JP 100V 12Amp 2.0m Power Cord	AF572A
	HP C13 - BS-1363A UK/HK/SG 250V 10Amp 1.83m Power Cord	AF570A
	HP C13 - SABS-164 ZA 250V 10Amp 2.5m Power Cord	AF567A
HP C13 - NBR-14136 BR 250V 10Amp 1.83m Power Cord	AF591A	

Technical Specifications

HP 3PAR StoreServ 7000 Product Dimensions, and Weight

Physical Dimensions	Height in/mm/U	Width in/mm	Depth in/mm	Max Weight lb/kg
42U Intelligent Series Rack	79.0/2006.6	23.5/597.8	42.7/1125.2	243/110 (empty)
HP 3PAR StoreServ 7200c 2N Storage Base (no host adapters, no drives)	3.46/87.95/2	19/483	26.6/676.1*	47.7/21.6
HP 3PAR StoreServ 7200c 2N Storage Base (with two host adapters, no drives)	3.46/87.95/2	19/483	26.6/676.1*	48.7/22.1
HP 3PAR StoreServ 7400c 2N Storage Base (no host adapters, no drives)	3.46/87.95/2	19/483	26.6/676.1*	47.7/21.6
HP 3PAR StoreServ 7400c 2N Storage Base (with two host adapters, no drives)	3.46/87.95/2	19/483	26.6/676.1*	48.7/22.1
HP 3PAR StoreServ 7400c 4N Storage Base (no host adapters, no drives)	6.925/175.9/4	19/483	26.6/676.1*	97.8/44.4
HP 3PAR StoreServ 7400c 4N Storage Base (with four host adapters, no drives)	6.925/175.9/4	19/483	26.6/676.1*	99.8/45.3
HP 3PAR StoreServ 7440c 2Node Storage Base (no host adapters, no drives)	3.46/87.95/2	19/483	26.6/676.1*	47.7/21.6
HP 3PAR StoreServ 7440c 2Node Storage Base (with two host adapters, no drives)	3.46/87.95/2	19/483	26.6/676.1*	48.7/22.1
HP 3PAR StoreServ 7440c 4Node Storage Base (no host adapters, no drives)	6.925/175.9/4	19/483	26.6/676.1*	97.8/44.4
HP 3PAR StoreServ 7440c 4Node Storage Base (with four host adapters, no drives)	6.925/175.9/4	19/483	26.6/676.1*	99.8/45.3
HP M6710 2.5 inch 2U SAS Drive Enclosures (without drives)	3.46/87.95/2	19/483	24.8/630.7	33.5/15.2
HP M6720 3.5 inch 4U SAS Drive Enclosures (without drives)	6.89/175/4	19/483	24.9/631.4	42.9/19.5
SFF SAS drive with carrier	3.42/86.85**	0.78/19.9**	896/227.7	0.7/0.32 (varies by type)

Technical Specifications

LFF SAS drive with carrier	1.18/30.0**	4.36/110.84**	8.67/220.26	1.9/0.86 (varies by type)
----------------------------	-------------	---------------	-------------	------------------------------

* includes length of ejector handles

** includes RFI clips

Power Requirements

Input Voltage (VAC)	100 - 240 VAC
Frequency (Hz)	50 - 60

Component	Idle (watts / BTU/hr)	Transactional (watts / BTU/hr)
Node Pair (7200/7200c or 7400/7400c), no drives, no add-on host adapters	236 / 803	398 / 1357
Node Pair (7440c), no drives, no add-on host adapters	344 / 1173	363 / 1238
4-port 8Gb/s Fibre Channel Adapter	24 / 81.7	32.6 / 111
2-port 10Gb/s iSCSI/FCoE Adapter	34 / 115.8	40 / 136.4
HP M6710 2.5 inch 2U SAS Drive Enclosure, no drives	150 / 512 (average)	150 / 512 (average)
HP M6720 3.5 inch 4U SAS Drive Enclosure, no drives	164 / 559 (average)	164 / 559 (average)
300GB 15K Small Form Factor HDD	6.2 / 21.1	8.0 / 27.3
450GB 10K Small Form Factor HDD	3.7 / 12.6	6.3 / 21.5
600 GB 10K Small Form Factor HDD	4.1/14	6.3/21.5
900GB 10K Small Form Factor HDD	4.8 / 16.4	6.2 / 21.1
1.2TB 10K Small Form Factor HDD	3.6/12.3	7.8/26.6
1 TB 7.2k Small Form Factor HDD	2.95/10.1	3.84/13.1
2TB 7.2K Large Form Factor NL HDD	7.5 / 25.6	10.6 / 36.1
3TB 7.2K Large Form Factor NL HDD	8.5 / 28.9	11.8 / 40.2
200GB SLC SSD	1.4 / 4.8	3.9 / 13.3
480GB MLC SSD	2.2/ 7.5	5.5/18.7
920GB MLC SSD	2.2/7.5	5.5/18.7
480GB cMLC SSD	3.2/11	7.1/24.4
1920GB cMLC SSD	3.5/11.9	8.9/30.5

Environmental Specifications

Operating Temperature	41° to 104° F (5° to 40° C) - Reduce rating by 1° F for each 1000 ft altitude (1.8° C/1,000 m)
Shipping Temperature	32° to 140° F (0° to 60° C)
Altitude (ft/m) max.	10,000 ft / 3,048 m
Shipping Altitude (ft/m) max.	40,000ft/ 12,192 m
Humidity	10% to 90% non condensing
Shipping Humidity	10% to 90% non condensing

Technical Specifications

Operating Vibration	0.25 G, Sine, 5-500 Hz, 0.1 Grms, Random 10-100Hz						
Non-operating Vibration	0.5 G, 5 - 500 Hz, Sine						
Operating Shock	2 G, 11 ms, half-sine						
Non-operating Shock	10 G, 11 ms, half-sine						
Maximum Air Flow	Storage Base and Upgrade Node Pair - 109 CFM per enclosure M6710 Drive Enclosure - 105 CFM M6720 Drive Enclosure - 109 CFM						
Electromagnetic Compatibility	CISPR 22:2008/ EN55022:2010 Class A CISPR 24:2010/ EN 55024:2010 IEC 61000-3-2:2005/ EN 61000-3-2:2006 +A1:2009 +A2:2009 IEC/ EN 61000-3-3:2008 AS/NZS CIPSR 22: 2009 Class A CNS 13438:2006 Class A 47 CFR Part 15 Subpart b Class A ICES-003 Issue 4 Class A V-3/2012.04 Class A RRA Notice No. 2011-24 (2011.12.23) Class A RRA Notice No. 2011-25 (2011.12.23)						
Acoustics	Fan Speed	7200c/7400c	7400c 4N	7440c 2N	7440c 4N	M6710 2.5"	M6720 3.5"
Sound pressure level measured per ISO 7779 specifications during normal operating fan conditions, from a minimum of 3,000 RPM to a maximum of 10,000 RPM	(RPM)	2N Storage Base	Storage Base	Storage Base	Storage Base	2U SAS Drive Enclosure	4U SAS Drive Enclosure
	Minimum	63.8	67.2	72	74	62.6	61.3
	Maximum	93.4	96.5	93	97	85.4	88
Safety	IEC 60950-1:2005 (2nd Edition) EN 60950-1:2006 +A11:2009 EN 62479:2010 CNS 14336-1 2nd Edition UL 60950-1 2nd Ed. CAN/CSA C22.2 No. 60950-1						
Certifications / Markings	cTUVus Mark TUV T-mark (EN 60950) CE Mark FCC Class A IC Class A VCCI Class A BSMI Class A KCC GOST-R C-Tick WEEE China RoHS EU RoHS						

NOTE: Specifications are subject to change without notice.

Overview - StoreServ File Controller

HP 3PAR StoreServ File Controller v2

HP 3PAR StoreServ File Controller v2 is a new converged storage capability on the HP 3PAR StoreServ Storage platform. It adds support for file services to the 3PAR StoreServ. The HP 3PAR StoreServ File Controller v2 is designed to deliver efficient, secure, and highly available file capability that supports hundreds to thousands of concurrent users.

What's New

- New 3PAR StoreServe File Controller v2

HP 3PAR StoreServ File Controller v2

The HP 3PAR StoreServ File Controller v2 sets the standard for performance and expandability for file services for the 3PAR StoreServ platform. It leverages the 3PAR StoreServ Storage data services and extends the benefits to file workloads. Please refer to the respective sections for details on the data services.

Models

HP 3PAR StoreServ File Controller v2 Storage	E7X02A
HP 3PAR StoreServ File Controller 1Gb Performance Kit	E7X04A
NOTE: This kit adds the second Intel® Xeon® E5-2609v2 Processor, an additional 16GB (4 x 4GB) of Memory, and a 1GbE 4 port NC365T Adapter to the 3PAR File Controller v2	
HP 3PAR StoreServ File Controller 10Gb Performance Kit	E7X05A
NOTE: This kit adds the second Intel® Xeon® E5-2609v2 Processor, an additional 16GB (4 x 4GB) of Memory, and a 10GbE 2 port 560SFP+ Adapter to the 3PAR File Controller v2	
HP 3PAR StoreServ File Controller	C8S69A

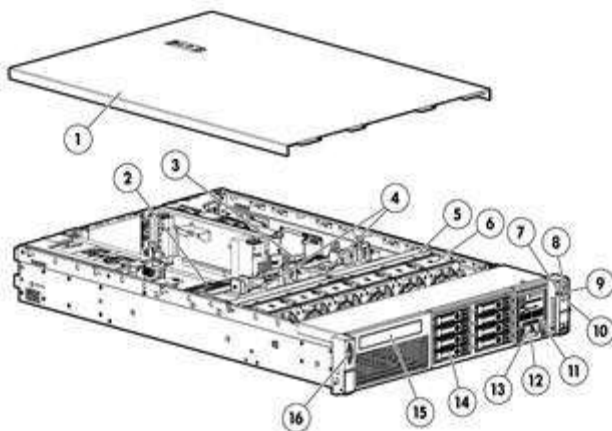

Front View:

1. Quick removal access panel
2. Second Intel Processor
3. First Intel Processor
4. 24 DIMM slots: DDR3 Registered (RDIMM), Load Reduced (LRDIMM), or Unbuffered (UDIMM) memory
5. Air Baffle
6. Hot-plug fans, full N+1 redundancy

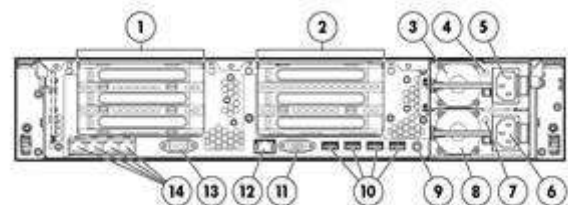

Rear View:

1. PCIe 3.0 Slots 1, 2, 3-PCIe 2.0 top to bottom
2. N/A
3. Power supply 1
4. Power supply 1 Power LED
5. Power supply 1 Power connection (with Intelligent PDU communication)
6. Power supply 2 Power connection (with Intelligent PDU communication)

Overview - StoreServ File Controller

- 7. Health LED
 - 8. Power On /Standby button and system power LED button
 - 9. USB connector
 - 10. Unit ID LED
 - 11. Systems Insight Display
 - 12. Asset Tag
 - 13. USB connector
 - 14. Drive Bays
 - 15. Optional Slim Optical Bay (SATA DVD-RW /ROM Optical Drive)
 - 16. Video connector
- communication)
 - 7. Power supply 2 Power LED
 - 8. Power supply 2
 - 9. Unit ID LED/Button
 - 10. USB connectors (4)
 - 11. Video connector
 - 12. iLO connector
 - 13. Serial connector
 - 14. FlexibleLOM ports (Shown: 4 ports 1Gb each /Optional: 2 ports 10Gb each)

Features and Benefits - StoreServ File Controller

Efficient: Save money and time

The HP 3PAR StoreServ File Controller v2 supports thousands users concurrently accessing their files. Non-intrusive variable chunk de-duplication delivers an average 50-60% space savings, and included evaluation tool facilitates capacity planning.

Consolidate multiple diverse file protocols (NFS: v2, v3, v4.1 | SMB: 2.0, 2.1, 3.0 | WebDAV | FTP/FTPS | HTTP/HTTPS) as well as IT services (e.g. print, DNS, DHCP) in a single platform.

Hosted BranchCache reduces your branch office WAN usage by automatically caching frequently accessed headquarter datacenter files.

Straightforward and consistent management experience that provides storage management for both file and block based workloads.

Bulletproof: Protect your data and organization always

Built in file system encryption and optional BitLocker Drive Encryption secures data at rest while SMB Encryption protects data in flight.

File Classification Infrastructure facilitates sophisticated access controls and support for Active Directory Rights Management Services protects files no matter where they go.

Online snapshots enable users to directly recover files and prior file versions.

Broad support for onboard endpoint protection (antivirus) software eliminates the need to purchase additional external infrastructure.

Broad support for agent-based data protection enhances the ability to meet backup and recovery SLAs.

Effortless: Simple to Manage and Monitor

Turnkey clustered controller configurations with transparent failover for SMB and NFS provide continuous availability.

Cluster aware updates enable online maintenance.

File system online self-healing, online verification, and precise and rapid repair massively reduce downtime from file corruption.

HP Active Health System, mirrored OS disks, RAID for data disks, redundant fans and power, and advanced memory protection maximize uptime.

Three year onsite parts and labor warranty for the system, and one year of software telephone support.

Standard Features - StoreServ File Controller

Operating System

Microsoft Windows Storage Server 2012 R2, Standard Edition

- Windows Storage Server 2012 R2 (WSS2012 R2) includes a robust range of file serving and storage capabilities. It addresses heterogeneous file workload environments and enables more efficient storage utilization. It allows for a flexible mix of configurations and includes advanced data management tools. WSS2012 leverages your Windows Server management skill sets and tools including Active Directory, PowerShell and System Center.
- SMB 3.0: Leverage high performance continually available file shares to deliver feature-rich storage for continuously available file services, business-critical applications and virtual servers using advanced new functionality.
- New VHDX Standard: Deploy larger capacity virtual storage that can grow to 16 terabytes, is more resilient against corruption, and provides more efficient usage of new 4 KB sector hard disks with the new VHDX virtual storage standard.
- Live Storage Migration: Maintain maximized service-level availability even while moving virtual machine storage between host servers independent of the actual virtual machine.
- SMB Multi-channel: Enable aggregation of network bandwidth and network fault tolerance when multiple paths are available between SMB clients and file servers.
- NFS v4.1: For Windows Storage Server 2012 R2, Server for NFS has been updated to support continuous availability. These improvements make it possible to reliably store and run VMware ESX on a virtual machine that is running Windows Server 2012 by using the NFS protocol to share files. Additional improvements in failover clustering take advantage of better resilience to hardware and software outages that may afflict individual cluster nodes. At the same time, failover clustering isolates VMware ESX hypervisor hosts from intermittent glitches during failovers.
- Data Deduplication: Data deduplication enables Windows Storage Server 2012 R2 to store more data in less physical space and achieve storage efficiency that is significantly higher than was possible in previous releases of Windows Storage Server that used Single Instance Storage (SIS) or NTFS file system compression. Data deduplication uses variable size chunking and compression, which deliver optimization ratios of 2:1 for general file servers and up to 20:1 for virtualization data. Evaluate your savings with the Deduplication Evaluation Tool.
- Volume Shadow Copy Service: Creates point-in-time copies (snapshots) of files and folders at predetermined time intervals that can then be accessed from client computers.
- VSS for Remote SMB File Shares: Leverage proven Volume Shadow Copy Service (VSS) to offload snapshot and backup operations to remote storage from VSS hardware providers within Hyper-V virtual machines.
- Hosted Branch Cache: Using client/server architecture, Windows 7 and above client computers can cache content on the local network via the Hosted Cache running on the 3PAR StoreServ File Controller. Other clients who need the same content retrieve it directly from the Hosted Cache.
- DFS Namespaces: Enables you to group shared folders that are located on different servers into one or more logically structured namespaces. Each namespace appears to users as a single shared folder with a series of subfolders. However, the underlying structure of the namespace can consist of numerous file shares that are located on different servers and in multiple sites.
- Distributed File System Replication (DFS-R): Enables you to efficiently replicate folders (including those referred to by a DFS namespace path) across multiple servers and sites. DFS Replication uses a compression algorithm known as remote differential compression (RDC). RDC detects changes to the data in a file, and it enables DFS Replication to replicate only the

Standard Features - StoreServ File Controller

- changed file blocks instead of the entire file.
- **Work Folders:** With Work Folders users can store and access work files on personal computers and devices, often referred to as bring-your-own device (BYOD), in addition to corporate PCs. Users gain a convenient location to store work files, and they can access them from anywhere. Organizations maintain control over corporate data by storing the files on centrally managed file servers, and optionally specifying user device policies such as encryption and lock-screen passwords. Work Folders can be deployed with existing deployments of Folder Redirection, Offline Files, and home folders. Work Folders stores user files in a folder on the server called a sync share. You can specify a folder that already contains user data, which enables you to adopt Work Folders without migrating servers and data or immediately phasing out your existing solution.
 - **File Server Resource Manager (FSRM):** File Server Resource Manager is a set of features that allow you to manage and classify data that is stored on file servers. File Server Resource Manager includes the following features:
 - **Storage reports:** Storage reports are used to help you identify trends in disk usage and how your data is classified. You can also monitor a selected group of users for attempts to save unauthorized files.
 - **File Classification Infrastructure:** File Classification Infrastructure provides insight into your data by automating classification processes so that you can manage your data more effectively. You can classify files and apply policies based on this classification. Example policies include dynamic access control for restricting access to files, file encryption, and file expiration. Files can be classified automatically by using file classification rules or manually by modifying the properties of a selected file or folder.
 - **File Management Tasks:** File Management Tasks enables you to apply a conditional policy or action to files based on their classification. The conditions of a file management task include the file location, the classification properties, the date the file was created, the last modified date of the file, or the last time the file was accessed. The actions that a file management task can take include the ability to expire files, encrypt files, or run a custom command.
 - **Quota management:** Quotas allow you to limit the space that is allowed for a volume or folder, and they can be automatically applied to new folders that are created on a volume. You can also define quota templates that can be applied to new volumes or folders.
 - **File screening management:** File screens help you control the types of files that user can store on a file server. You can limit the extension that can be stored on your shared files. For example, you can create a file screen that does not allow files with an MP3 extension to be stored in personal shared folders on a file server.
 - **Initial Configuration Tasks Wizard:** Simplifies and accelerates new device deployment by presenting basic system settings on your first boot.
 - **Server Manager**
 - **" Print Management Console:** Manage multiple printers (license for unlimited printer support) from a single console, whether locally or over the WAN
 - **Unlimited Client Access Licenses (CALs) included**

NOTE: Windows Storage Server 2012 R2 and Windows Server 2012 R2 are built on the same code base. Applications certified for Windows Server are expected to have the same application compatibility profile on Windows Storage Server. Windows Storage Server 2012 R2 and Windows Server 2012 R2 have the same application frameworks, services and plumbing to support running the full breadth of

Standard Features - StoreServ File Controller

Window-compatible applications. Applications that rely upon certain roles that are removed from Windows Storage Server 2012 R2, such as fax server, active directory domain controller or terminal services will not be able to leverage those roles. Independent Software Vendors (ISVs) ultimately decide what versions and editions of Windows are supported by their products and users should review ISV compatibility and support information before purchasing. HP StoreEasy customers should review the End User License Agreement (EULA) to see the types of applications that are permitted for installation. All versions of Windows Storage Server can join Active Directory domains, but cannot be a domain controller.

More information on Windows Storage Server 2012 R2, Standard Edition can be found here:

<http://www.microsoft.com/en-us/server-cloud/windows-storage-server/default.aspx>

<http://technet.microsoft.com/en-us/library/jj643303>

Processor / Cache Memory	Intel® Xeon® E5-2609v2 (2.50GHz/4-core/10MB/80W) Processor (3PAR StoreServ File Controller v2)	
	Intel® Xeon® E5-2609 (2.40GHz/4-core/10MB/80W) Processor (3PAR StoreServ File Controller)	
Memory	Type	DDR3 Registered (RDIMM) standard
	Standard	16GB (4 x 4GB)
	DIMM Sockets	24
Network Controller	NIC Ports	4
	Controller	HP Ethernet 1Gb 4-port 331FLR Adapter

HP 3PAR StoreServ File Controller v2

Expansion Slots

Primary Riser (Standard)	Expansion Slots #	Technology	Bus Width**	Connector Width	Bus Number*	Form Factor	Notes
	1	PCIe 3.0	X16	X16	7	Full Length, Full Height Slot	Proc 1
	2	PCIe 3.0	X8	X8	10	Half Length, Full Height Slot	Proc 1
	3	PCIe 2.0	X4	X8	13	Half Length, Full Height Slot	Chipset

* Default bus assignment (in decimal). Inserting cards with PCI bridges may alter the actual bus assignment number

** Indicates the number of physical electrical lanes running to the connector.

NOTE: When populating the second optional riser slot, the second processor must be installed.

NOTE: All slots support up to 150w PCIe cards, but an additional Power Cord Option is required (PN 669777-B21). See Option Section below for offering.

PCIe Riser (Optional 3-slot)	Expansion Slots #	Technology	Bus Width**	Connector Width	Bus Number*	Form Factor	Notes
	4	PCIe 3.0	X16	X16	16	Full Length, Full Height Slot	Proc 2

Standard Features - StoreServ File Controller

5	PCIe 3.0	X8	X8	20	Half Length, Full Height Slot	Proc 2
6	PCIe 3.0	X4	X8	23	Half Length, Full Height Slot	Proc 2

* Default bus assignment (in decimal). Inserting cards with PCI bridges may alter the actual bus assignment number

** Indicates the number of physical electrical lanes running to the connector.

NOTE: When populating the second optional riser slot, the second processor must be installed.

NOTE: All slots support up to 150w PCIe cards, but an additional Power Cord Option is required (669777-B21). See Option Section below for offering

Storage Controller	NOTE: HP 3PAR StoreServ File Controller includes a storage controller designed for internal drives housing the O/S mirror only; an HBA is required to address connectivity to the 3PAR StoreServ Storage array.	
Controller(s)	HP Smart Array P420i/1GB with FBWC	
RAID	Needed for internal drive mirror only	
Storage	Hard Drives	
	Internal	Eight 2.5" (Small Form Factor) hot-plug bays <ul style="list-style-type: none"> • 2 x 300GB 6G SAS 10K SFF HDDs for OS mirror (3PAR File Controller v2) • 2 x 450GB 6G SAS 10K SFF HDDs for OS mirror (3PAR File Controller)
	External	3PAR StoreServ Storage using Fibre Channel
Power Supply	2 x 460 Watts Platinum	
Power Cords	NOTE: The HP 3PAR StoreServ File Controller is primarily connected to PDU's in data center racks so they now ship standard with only a PDU 6-foot C-14 to C13 power cord (142258-001). If a user wishes to power a system using a 110V receptacle see Power Cord option section for more options.	
System Fans	(4) (N+1 redundancy standard)	
Form Factor	2U Rack form factor	
Host Bus Adapter (HBA) Support	HP 3PAR StoreServ File Controller is designed to be connected to a HP 3PAR StoreServ Storage array by adding a recommended Fibre Channel HBA.	

Service and Support, HP Care Pack, and Warranty Information - StoreServ File Controller

Warranty

3 Year, On-site Warranty Service. 7x24 4-hour remote response with next business day on-site response.

HP warrants only that the Software media will be free of physical defects for a period of ninety (90) days from delivery.

Services Included with the Product One year of HP Software Support, standard 9x5 business hours (software advisory and remedial software telephone support, new version license rights, and media and documentation distribution service).

For increased uptime, productivity and ROI-HP Care Pack packaged services for Storage

These days, you need to get the most out of your storage investment-you can't afford not to. When you buy HP storage products and solutions, it's also a good time to think about what levels of service and support you may need. To help take the worry out of deploying, designing, maintaining, and managing your environment, we've designed a portfolio of service options that are as: flexible, reliable and scalable as your storage. Unlike storage-only vendors, we take a holistic approach to your entire environment, bridging storage, servers, blades, software and network infrastructures with our HP Care Pack packaged services for Storage.

Protect your business beyond the warranty

When it comes to robustness and reliability, standard warranties on today's computing equipment have matured just as the technologies have matured. Good news on some fronts-but also a source of potential problems and subsequent consequences that come from depending on standard warranties alone. Standard warranty protects against product defects and some causes of downtime- but not the business. By using a standard approach to warranty uplifts, such as HP Care Pack Services, you can reduce downtime risks and be more certain of operational consistency for both mission-critical and standard business computing. Simply put, HP Care Pack Services normalize the warranty of combined products - helping you proactively guard against unplanned downtime.

Extending warranties with HP Care Pack Services

For cost-effective upgrading or extending your standard warranty, HP Care Pack Services offer a suite of standard reactive hardware and software support services that are sold separately, or combined as with our Foundation Care 24x7 services. The portfolio also provides a combination of proactive and reactive services, such as Proactive 24 Service and Critical Service. In addition, with HP Proactive Select we offer an innovative approach to service delivery that gives you the flexibility to acquire the specific proactive services you need today, then add services as your needs evolve. HP Proactive Select offers a broad set of technical or per-event type service options - including server, storage, and network, SAN device, and software, environment, installation and education services. Services that you can mix and match depending on your specific requirements, from preliminary planning and equipment delivery to installation, configuration, integration, and testing, through every level of ongoing support. Our HP Care Pack packaged services for Storage assures help when you need it most. And for many products, post-warranty HP Care Pack Services are available when your original warranty has expired.

HP Storage Services: Offering reliability, flexibility and value-just like your storage

HP Storage Services offers a full spectrum of customer care, from technology support to complex migrations to complete completely managed services. HP Factory Express provides customization, integration and deployment services for turnkey solutions. HP Education offers flexible, comprehensive training on storage networking, disk storage systems, and storage software to help your IT staff get the most out of your investments. And HP Financial solutions extend innovative financing and asset management programs to cost-effective buy, manage and eventually retire your older equipment.

HP Storage Services, the trusted business technology experts who manage your technology in action, because when technology works, business works. <http://www.hp.com/hps/storage>

Service and Support, HP Care Pack, and Warranty Information - StoreServ File Controller

NOTE: Care Pack Services availability may vary by product and country.

HP Care Pack Services are sold by HP and HP Authorized Service Partners

- Services for customers purchasing from HP or an enterprise reseller are quoted using HP order configuration tools.
- Customers purchasing from a commercial reseller can find HP Care Pack Services at <http://www.hp.com/go/lookuptool>

Recommended HP Care Pack Services for optimal satisfaction with your HP product.

Recommended Services HP Foundation Care 24x7 connects you to HP 24 hours a day, seven days a week for assistance on resolving issues - hardware onsite response within four hours and software call back within two hours after opening your case. Three years' coverage recommended with HP Care Pack Service.

HP Installation and Startup Service for 3PAR StoreServ File Controller

For smooth startup, HP Installation and Startup Service provides for deployment of your HP 3PAR StoreServ File Controller while helping you establish readily available access to and management of your critical data and applications. Leverage the full strength of HP Technology Services - customers can trust the services professionals at HP to work collaboratively with them, putting our strategic and technical know-how to work across their entire infrastructure.

- System installation and setup by a HP technical specialist
- Reduced implementation time and cost
- Verification prior to installation that all service prerequisites are met
- Availability of an HP service specialist to answer basic questions related to this service during the orientation session
- Potential expansion of the number of shares and hosts
<http://h20195.www2.hp.com/v2/GetPDF.aspx/4AA2-6112ENL.pdf>

HP Proactive Select Service

HP Proactive Select Service improves your IT performance and manageability through the use of cost effective flexible services. HP provides technical expertise and best practices to accelerate ROI of your technology investment. Selectable proactive services span a wide range of technology and process services - a flexible way to purchase proactive services that fit your particular environment and situation.

HP Proactive Select Service is technology agnostic and purchased in addition to your choice of underlying reactive support.

- Access to a list of flexible and customizable proactive service activities
- Enhance customers' in-house IT team with complementary assistance from HP
- Improved time to solution
- Reduce business risk and project costs by accessing HP specialists
- Simplify IT operational procedures by leveraging HP best practices

<http://h20195.www2.hp.com/v2/GetPDF.aspx/4AA2-3842ENN.pdf>

Service and Support, HP Care Pack, and Warranty Information - StoreServ File Controller

Optional HP Care Pack Services that will enhance your HP product experience.

Optional Services

HP Data Migration Service for Windows

For customers who need to safely migrate Windows data within their TCP/IP networks with minimal impact to their operations:

You have a need to migrate data between Windows servers within your TCP/IP network. Or you have a need to migrate storage for your Windows servers. Or both. And you need to accomplish these migrations efficiently while minimizing risk at the same time.

HP Data Migration Service for Windows offers you a cost competitive and convenient way to accommodate data migration triggered by a need to refresh or consolidate storage, or to create different storage tiers. This service offers a migration cost in line with the costs of storage products in small and medium-sized storage environments. The service is delivered via a skilled HP service specialist with special consideration for data availability, integrity, and ongoing operational performance during the transfer process.

<http://h20195.www2.hp.com/v2/GetPDF.aspx/4AA2-4734ENW.pdf>

eSupport

HP eSupport is a portfolio of technology-based services that assist you with managing your business environment - from the desktop to the data center.

Support Portal

The HP support portal provides one-stop access to the information, tools and services you need to manage the daily operations of your IT environment.

Features include:

- Access to self-solve tools (including search technical knowledge base)
- Efficient logging and tracking of support cases
- Collaboration with other business and IT professionals
- Download of patches and drivers
- Access to diagnostic tools
- Proactive notification of relevant information

Access to certain features of the support portal requires an HP service agreement. To access the support portal, visit: <http://www.hp.com/support>

Customer Technical Training

Consider education as an integral part of your strategy to get the best return on investment for your HP storage solution. HP offers a variety of training courses on storage software, networking, archiving and disk storage systems. Our classes are available in many delivery modalities from traditional instructor-led courses at one of our 80 training centers worldwide to on-site training customized to your needs or online. www.hp.com/learn/storage

HP Services Awards

HP Services continues to be recognized for service and support excellence by customers, partners, industry organizations and publications around the world. Recent honors and award reflect our services team's dedications, technical expertise, professionalism and uncompromising commitment to customer satisfaction. For a list of all our awards, please visit:

<http://h20219.www2.hp.com/services/cache/433028-0-0-225-121.html>

Service and Support, HP Care Pack, and Warranty Information - StoreServ File Controller

Additional Services Information

For more information about HP Care Pack Services for Storage, please visit:

<http://www.hp.com/hps/storagelf> you have specific questions, contact your local HP representative.

Contact information for a representative in your area can be found at "Contact HP" <http://www.hp.com>

Storage - StoreServ File Controller

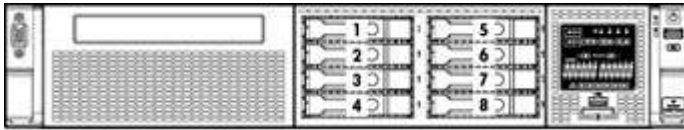

1-8

Eight 3.5" (LFF) hot plug hard drive bays
(File Controller ships with only two SAS
drives for OS)

Storage - StoreServ File Controller

3PAR StoreServ File Controller			
System Unit	Dimensions (H x W x D) (with bezel)	SFF Drives: 3.44 x 17.54 x 27.50 in (8.73 x 44.55 x 69.85 cm)	
	Weight (approximate)	Maximum (all hard drives, power supply, and processor installed)	61.00 lb (27.66 kg)
		Minimum (one hard drive, power supply, and processor installed)	41.0 lb (18.59 kg)
	Input Requirements (per power supply)	Rated Line Voltage	100 to 120 VAC 200 to 240 VAC
		Rated Input Current	For 1200 W Power Supply: 10 A (at 100 VAC), 4.9 A (at 200 VAC) For 750 W Power Supply: 8.9 A (at 100 VAC), 4.3 A (at 200 VAC) For 460 W Power Supply: 5.5 A (at 100 VAC), 2.6 A (at 200 VAC)
		Rated Input Frequency	50 to 60 Hz
		Rated Input Power	For 1200 W Power Supply: 930 W (at 100 VAC), 1348 W (at 200 VAC) For 750 W Power Supply: 857 W (at 100 VAC), 824 W (at 200 VAC) For 460 W Power Supply: 526 W (at 100 VAC), 505 W (at 200 VAC)
	BTU Rating	Maximum	For 1200 W Power Supply: 3530 BTU/hr (at 100 VAC), 4600 BTU/hr (at 200 VAC) For 750 W Power Supply: 2925 BTU/hr (at 100 VAC), 2812 BTU/hr (at 200 VAC) For 460 W Power Supply: 1794 BTU/hr (at 100 VAC), 1725 BTU/hr (at 200 VAC)
	Power Supply Output (per power supply)	Rated Steady-State Power	For 1200 W Power Supply: 800 W (at 100 VAC), 900 W (at 120 VAC), 1200 W (at 200 to 240 VAC) For 750 W Power Supply:

Storage - StoreServ File Controller

			750 W (at 100 to 120 VAC), 750 W (at 200 to 240 VAC) For 460 W Power Supply: 460 W (at 100 to 120 VAC), 460 W (at 200 to 240 VAC)
		Maximum Peak Power	For 1200 W Power Supply: 800 W (at 100 VAC), 900 W (at 120 VAC), 1200 W (at 200 to 240 VAC) For 750 W Power Supply: 750 W (at 100 to 120 VAC), 750 W (at 200 to 240 VAC) For 460 W Power Supply: 460 W (at 100 to 120 VAC), 460 W (at 200 to 240 VAC)
System Inlet Temperature	Operating		10° to 35°C (50° to 95°F) at sea level with an altitude derating of 1.0°C per every 304.8 m (1.8°F per every 1000 ft) above sea level to a maximum of 3048 m (10,000 ft), no direct sustained sunlight. Maximum rate of change is 10°C/hr (18°F/hr). The upper limit may be limited by the type and number of options installed. System performance may be reduced if operating with a fan fault or above 30°C (86°F).
	Non-operating		-30° to 60°C (-22° to 140°F). Maximum rate of change is 20°C/hr (36°F/hr).
Relative Humidity (non-condensing)	Operating		10% to 90% relative humidity (Rh), 28°C (82.4°F) maximum wet bulb temperature, non-condensing.
	Non-operating		5% to 95% relative humidity (Rh), 38.7°C (101.7°F) maximum wet bulb temperature, non-condensing.
Altitude	Operating		3048 m (10,000 ft). This value may be limited by the type and number of options installed. Maximum allowable altitude change rate is 457 m/min (1500 ft/min).
	Non-operating		9144 m (30,000 ft). Maximum allowable altitude change rate is 457 m/min (1500 ft/min).
Acoustic Noise	Listed are the declared A-Weighted sound power levels (LWAd) and declared average bystander position A-Weighted sound pressure levels (LpAm) when the product is operating in a 23°C ambient environment. Noise emissions were measured in accordance with ISO 7779 (ECMA 74) and declared in accordance with ISO 9296 (ECMA 109). The listed sound levels apply to standard shipping configurations. Additional options may result in increased sound levels. NOTE: The Listed sound levels apply to standard shipping configurations. Additional options may result in increased sound levels.		
	Idle		
		LWAd	4.1 B
		LpAm	25 dBA

Storage - StoreServ File Controller

	Operating	
	LWAd	4.3 B
	LpAm	27 dBA
Emissions Classification (EMC)	FCC Rating	Class A
	Normative Standards	CISPR 22; EN55022; EN55024; FCC CFR 47, Pt 15; ICES-003; CNS13438; GB9254; K22;K24; EN 61000-3-2; EN 61000-3-3; EN 60950-1; IEC 60950-1
	<p>NOTE: Product conformance to cited product specifications is based on sample (type) testing, evaluation, or assessment. This product or family of products is eligible to bear the appropriate compliance logos and statements.</p> <p>NOTE: The Listed sound levels apply to standard shipping configurations. Additional options may result in increased sound levels.</p>	

HP iLO 4 On System Management

Architecture	PCI Express based health and remote management ASIC
Processor	Embedded ARM processor core operating at 400MHz
Upgradeability	Firmware upgradeable via Flash ROM
Video Support	1920 x 1200 (16 bpp) DVR max resolution
Interfaces	<p>P iLO Dedicated* Network connection (10/100/1000 Mb/s) on rack, tower and SL systems</p> <p>*Optional Module on some servers</p> <p>HP iLO Shared Network connection (10/100/1000 Mb/s) on rack, tower and SL systems</p> <p>HP iLO network connection to blades (100 Mb/s) to Onboard Administrator (with 10/100/1000 Mb/s uplink) on blade systems</p>
Memory	<p>16 MB Flash</p> <p>256 MB DDR 3 with ECC (112 MB after ECC and video)</p>
Operating System Support	<p>For information on HP's Certified and Supported ProLiant Servers for OS and Virtualization Software and latest listing of software drivers available for your server including how to purchase from HP, please visit our OS Support Site at: http://www.hp.com/go/ossupport</p>
Client System Support	<p>For information on Client System Support, please visit the HP iLO Feature Comparison Site at: www.hp.com/go/compareilo</p>
Client Browser Support	<p>Microsoft Internet Explorer 9</p> <p>NOTE: For customers using Protected Mode, please use the Java based version of Integrated Remote Console.</p> <p>Microsoft Internet Explorer 8</p> <p>NOTE: For customers using Protected Mode, please use the Java based version of Integrated Remote Console.</p> <p>Microsoft Internet Explorer 7</p> <p>Firefox Extended Support Release (ESR) 10 (on supported Windows and Linux systems)</p> <p>Firefox 3.6 (on supported Windows and Linux systems)</p>
Command Line Support	Secure Shell and serial port access

Storage - StoreServ File Controller

	Secure Socket Layer
	Secure Shell version 2
Security	Advanced Encryption Standard (AES) and Triple Data Encryption Standard (3DES) on browser, CLP and XML scripting interface
	AES encryption of video
	RC4 encryption of video
Directory Support Services	Active Directory v1.0 (Windows 2003)
Driver Support	HP ProLiant iLO 4 Management Controller Driver Package
Management protocols supported	SNMP, IPMI 2.0 (system and LAN interface), DMTF Systems Management Architecture for Server Hardware Command Line Protocol (SMASH CLP), HP RIBCL XML

HP Smart Array P420i Controller	Dimensions	Embedded
	Disk Drive and Enclosure Interface - Transfer rate	6Gb/s SAS (Serial Attached SCSI) 3Gb/s SATA (Serial ATA)
	SAS Connectors	2 internal 4X connectors
	Cache Memory Speed	512MB FBWC - DDR3-1333MHz with 40-bit wide bus, 1GB or 2GB FBWC DDR3-1333MHz with 72-bit wide bus
	Server Interface	x8 PCIe 3.0 provides 8GB/s maximum bandwidth
	SAS Speed	(8) 6Gb/s SAS links provide 4.8GB/s maximum bandwidth
	Cache Memory	Zero Memory RAID has no cache memory 40-bit 256MB ECC protected cache (battery upgrade available) 72-bit 512MB BBWC or 72-bit 512MB and 1G FBWC
	Logical Drives Supported	Zero Memory, Up to 2 logical volumes (8SFF or 4LFF physical drives) Up to 64 logical drives with cache
	Host Memory Addressing	64-bit, supporting greater than 4GB server memory space

HP Ethernet 1Gb 4-port 331FLR Adapter	HP Flexible Network Technology	HP Flexible Network Technology consists of replaceable network solutions to meet the customers require now or in the future.	
	Network Interface	10Base-T/100Base-TX/1000Base-TX	
	Compatibility	IEEE 802.3 10Base-T	
		IEEE 802.3ab 1000Base-T	
		IEEE 802.3ad 1000Base-TX	
		IEEE 802.1p 100Base-TX	
		IEEE 802.1q 100Base-TX	
	Data Transfer Method	PCI Express, four lanes (x4)	
	Controller	BCM5719	
	Network Transfer Rate	10Base-T (Half-Duplex)	10 Mb/s
10Base-T (Full-Duplex)		20 Mb/s	
100Base-TX (Half-Duplex)		100 Mb/s	
100Base-TX (Full-Duplex)		200 Mb/s	

Storage - StoreServ File Controller

	1000Base-TX (Half and Full-Duplex)	2000 Mb/s
Connector	Two RJ-45	
Cable Support	10Base-T	Categories 3, 4 or 5 UTP; up to 328 ft (100 m)
	10/100/1000Base-TX	Category 5 or higher UTP; up to 328 ft (100 m)

Environment-friendly Products and Approach

End-of-life Management and Recycling

Hewlett-Packard offers end-of-life HP product return, trade-in, and recycling programs in many geographic areas. For trade-in information, please go to: <http://www.hp.com/go/green>. To recycle your product, please go to: <http://www.hp.com/go/green> or contact your nearest HP sales office. Products returned to HP will be recycled, recovered or disposed of in a responsible manner.

The EU WEEE directive (2002/95/EC) requires manufacturers to provide treatment information for each product type for use by treatment facilities. This information (product disassembly instructions) is posted on the Hewlett Packard web site at: <http://www.hp.com/go/green>. These instructions may be used by recyclers and other WEEE treatment facilities as well as HP OEM customers who integrate and re-sell HP equipment.

Appendix

Appendix

This Appendix includes the technical specification of the HP 3PAR StoreServ 7200 and HP 3PAR StoreServ 7400 Storage.

Summary	3PAR StoreServ 7200	3PAR StoreServ 7400
Number of Controller Nodes	2	2 or 4
HP 3PAR Gen4 ASICs	2	2 or 4
Processors	2 four-core 1.8 GHz	2 - 4 six-core 1.8 GHz
Total Cache	792 GB	1564 GB
Flash Cache (optional)	768 GB	1500 GB
On-Node Cache	24 GB	64 GB
Total Cache per controller node pair	792 GB	832 GB
Flash Cache per node pair	768 GB	768 GB
On-Node Cache per node pair	24 GB	64 GB
Maximum Host Ports	12 ports	24 ports
8Gb/s Fibre Channel Host Ports	4 - 12 ports	4 - 24 ports
16Gb/s Fibre Channel Host Ports	0 - 4 ports	0 - 8 ports
10Gb/s iSCSI Host Ports	0 - 4 ports	0 - 8 ports
1GbE/10GbE Network Ports	Not Applicable	Not Applicable
Maximum Initiators Supported	1024	1024 or 2048
2U Controller Enclosure SAS Drive Capacity	24	24
Number of Disk Drives	8 - 240 drives	8 - 480 drives
Number of Solid State Drives	8 ¹ - 120	8 ¹ - 240
Raw Capacity (approx.) ²	1.2 - 400 TB ³	1.2 - 1200 TB ³

Capacity Details	3PAR StoreServ 7200	3PAR StoreServ 7400
RAID Levels	RAID 0, 1, 5, 6	RAID 0, 1, 5, 6
RAID 5 Data to Parity Ratios	2:1 - 8:1	2:1 - 8:1
RAID 6 Data to Parity Ratios	4:2, 6:2, 8:2, 10:2, 14:2	4:2, 6:2, 8:2, 10:2, 14:2
Drive Capacities (approximate GB ³) (RAID levels, parity ratios, and drive capacities all mixable within the same Storage System)	200 SSD ⁴ , 480 SSD ⁴ , 920 SSD ⁴ , 480GB cMLC SSD, 1.92TB cMLC SSD, 300 15K SAS, 450 10K SAS, 600 10K SAS, 900 10K SAS, 1200 10K SAS, 1000 7.2K NL, 2000 7.2K NL ⁵ , 3000 7.2K NL ⁵ , 4000 7.2K NL ⁵	200 SSD ⁴ , 400 SSD ⁴ , 480 SSD ⁴ , 920 SSD ⁴ , 480GB cMLC SSD, 1.92TB cMLC SSD, 300 15K SAS, 450 10K SAS, 600 10K SAS, 900 10K SAS, 1200 10K SAS, 1000 7.2K NL, 2000 7.2K NL ⁵ , 3000 7.2K NL ⁵ , 4000 7.2K NL ⁵
Number of Add-on Drive Enclosures (Each Drive Enclosure holds up to 24 drives in 2U for small form factor drives and 4U for large form factor drives)	0 - 9 enclosures	0 - 18 enclosures

¹ The minimum drive quantity is permitted as long as the total raw capacity is at least 1.2 TB.

² Maximum raw capacity currently supported with any and all drive types.

³ For storage capacity, 1 GB = 1,000,000,000 bytes and 1 TB = 1,000 GB.

Appendix

⁴ SSDs are Solid State Drives.

⁵ NL drives are 7200 RPM Enterprise SAS drives.

NOTE: Specifications are subject to change without notice.

HP 3PAR StoreServ 7200 All-Flash Starter Kit

HP 3PAR StoreServ 7200 All-Flash Starter Kit is an all-flash version of the HP 3PAR StoreServ 7200 providing mid-range customers with all-flash acceleration at entry-level price. The kit includes the HP 3PAR StoreServ 7200 Storage System Base equipped with 8 x 480GB SFF cMLC SSD drives, Reporting Suite and Virtual Copy software.

The HP 3PAR StoreServ 7200 All-Flash Starter Kit has the same Drive LTUs cap and maximum number of SSDs as the HP 3PAR StoreServ 7200. The Drive LTUs cap for HP 3PAR StoreServ 7200 All-Flash Starter Kit is 48. After reaching the cap, you do not need to purchase any more Drive LTUs for that title. The maximum number of SSDs is 120.

Model

HP 3PAR StoreServ 7200 All-Flash Starter Kit

K2Q09A

The HP 3PAR StoreServ 7200 All-Flash Starter Kit is an orderable part number that includes the following individual parts.

Quantity	Component	
1	HP 3PAR StoreServ 7200 Storage System Base	QR482A
8	HP M6710 480GB 6G SAS 2.5in cMLC SSD	E7Y55A
1	HP 3PAR 7200 Operating System Software Suite Base LTU	BC745B
8	HP 3PAR 7200 Operating System Software Suite Drive LTU	BC746A
1	HP 3PAR 7200 Reporting Suite Base LTU	BC767B
1	HP 3PAR 7200 Virtual Copy Base LTU	BC753A
8	HP 3PAR 7200 Virtual Copy Drive LTU	BC754A

NOTE: Users can add more SSDs, drive enclosures (and any other 7000 accessory), and software to the HP 3PAR StoreServ 7200 All-Flash Starter Kit quote. Each of the nested components will appear as separate parts on the quote and will be priced accordingly

HP 3PAR StoreServ 7000 Product Dimensions, and Weight

Physical Dimensions	Height in/mm/U	Width in/mm	Depth in/mm	Max Weight lb/kg
42U Intelligent Series Rack	79.0/2006.6	23.5/597.8	42.7/1125.2	243/110 (empty)
HP 3PAR StoreServ 7200 2-node Storage Base (no host adapters, no drives)	3.46/87.95/2	19/483	26.6/676.1*	47.7/21.6
HP 3PAR StoreServ 7200	3.46/87.95/2	19/483	26.6/676.1*	48.7/22.1

Appendix

2-node Storage Base

(with two host adapters, no drives)

HP 3PAR StoreServ 7400 3.46/87.95/2 19/483 26.6/676.1* 47.7/21.6

2-node Storage Base (no host adapters, no drives)

HP 3PAR StoreServ 7400 3.46/87.95/2 19/483 26.6/676.1* 48.7/22.1

2-node Storage Base

(with two host adapters, no drives)

HP 3PAR StoreServ 7400 6.925/175.9/4 19/483 26.6/676.1* 97.8/44.4

4-node Storage Base (no host adapters, no drives)

HP 3PAR StoreServ 7400 6.925/175.9/4 19/483 26.6/676.1* 99.8/45.3

4-node Storage Base

(with four host adapters, no drives)

HP M6710 2.5 inch 2U 3.46/87.95/2 19/483 24.8/630.7 33.5/15.2

SAS Drive Enclosures (without drives)

HP M6720 3.5 inch 4U 6.89/175/4 19/483 24.9/631.4 42.9/19.5

SAS Drive Enclosures (without drives)

SFF SAS drive with carrier 3.42/86.85** 0.78/19.9** 896/227.7 0.7/0.32 (varies by type)

LFF SAS drive with carrier 1.18/30.0** 4.36/110.84** 8.67/220.26 1.9/0.86 (varies by type)

* includes length of ejector handles

** includes RFI clips

Environmental Specifications

Operating Temperature	41° to 104° F (5° to 40° C) - Reduce rating by 1° F for each 1000 ft altitude (1.8° C/1,000 m)
Shipping Temperature	32° to 140° F (0° to 60° C)
Altitude (ft/m) max.	10,000 ft / 3,048 m
Shipping Altitude (ft/m) max.	40,000ft/ 12,192 m
Humidity	10% to 90% non condensing
Shipping Humidity	10% to 90% non condensing
Operating Vibration	0.25 G, Sine, 5-500 Hz, 0.1 Grms, Random 10-100Hz
Non-operating Vibration	0.5 G, 5 - 500 Hz, Sine
Operating Shock	2 G, 11ms, half-sine

Appendix

Non-operating Shock	10 G, 11 ms, half-sine				
Maximum Air Flow	Storage Base and Upgrade Node Pair - 109 CFM per enclosure M6710 Drive Enclosure - 105 CFM M6720 Drive Enclosure - 109 CFM				
Electromagnetic Compatibility	CISPR 22:2008/ EN55022:2010 Class A CISPR 24:2010/ EN 55024:2010 IEC 61000-3-2:2005/ EN 61000-3-2:2006 +A1:2009 +A2:2009 IEC/ EN 61000-3-3:2008 AS/NZS CIPSR 22: 2009 Class A CNS 13438:2006 Class A 47 CFR Part 15 Subpart b Class A ICES-003 Issue 4 Class A V-3/2012.04 Class A RRA Notice No. 2011-24 (2011.12.23) Class A RRA Notice No. 2011-25 (2011.12.23)				
Acoustics	Fan Speed	7200/7400 2	7400	M6710 2.5"	M6720 3.5"
Sound pressure level measured per ISO 7779 specifications during normal operating fan conditions, from a minimum of 3,000 RPM to a maximum of 10,000 RPM	(RPM)	node Storage Base	4 node Storage Base	2U SAS Drive Enclosure	4U SAS Drive Enclosure
	Minimum	63.8	67.2	62.6	61.3
	Maximum	93.4	96.5	85.4	88
Safety	IEC 60950-1:2005 (2nd Edition) EN 60950-1:2006 +A11:2009 EN 62479:2010 CNS 14336-1 2nd Edition UL 60950-1 2nd Ed. CAN/CSA C22.2 No. 60950-1				
Certifications / Markings	cTUVus Mark TUV T-mark (EN 60950) CE Mark FCC Class A IC Class A VCCI Class A BSMI Class A KCC GOST-R C-Tick WEEE China RoHS EU RoHS				

NOTE: Specifications are subject to change without notice.

Summary of Changes

Date	Version History	Action	Description of Change:
1-Dec-2014	From Version 30 to 31	Changed	Added section about HP 3PAR File Persona Software Suite
20-Nov-2014	From Version 31 to 30	Changed	The document was reverted to version 30 at BU request.
10-Nov-2014	From Version 30 to 31	Changed	Changes were made throughout the QuickSpecs.
29-Sep-2014	From Version 29 to 30	Changed	Changes were made throughout the QuickSpec.
22-Aug-2014	From Version 28 to 29	Changed	Removed this entire bullet: "Encrypted and non-encrypted drives can be mixed in a non-encrypted array"
20-Aug-2014	From Version 27 to 28	Changed	Changes made to the Overview section. Update some SKU descriptions.
18-Aug-2014	From Version 26 to 27	Changed	Changes were made throughout the QuickSpec.
18-Jul-2014	From Version 25 to 26	Changed	Configuration section – WSS2012 R2 Upgrade section added (D4T73A); Standard Features – Power Supply changed from 2x 460 W to 2 x 750 W;
10-jun-2014	From Version 24 to 25	Changed	Overview table info, standard features resilient part; carepack information
05-Jun-2014	From Version 23 to 24	Changed	Change made in Overview
01-Jun-2014	From Version 22 to 23	Changed	Change made in step 5
11-apr-2014	From Version 21 to 22	Changed	Overview chart, Step 11 in Configuration, Models, and Technical Specifications chart were revised.
04-apr-2014	From Version 20 to 21	Changed	Corrected the images in the Configuration section.
31-mar-2014	From Version 19 to 20	Changed	Changes were made throughout.
24-mar-2014	From Version 18 to 19	Changed	Image correction.
17-Jan-2014	From Version 17 to 18	Changed	Maximum Initiators Supported was revised in the overview chart.
10-dec-2013	From Version 16 to 17	Added	Added the missing image to Step 1.
09-dec-2013	From Version 15 to 16	Changed	Overview and Configuration were revised.
30-sep-2013	From Version 14 to 15	Added	Proactive Select credits available for an additional price note was added to Service and Support, HP Care Pack and Warranty Information HP 3PAR StoreServ M6710 Midline 1TB 6Gb SAS 7.2K SFF Nearline HDD was added to Step 4 in Configuration Information
19-aug-2013	From Version 13 to 14	Changed	Fibre Channel Switches and HP Intelligent Infrastructure Analyzer Software (IIAS) were revised in Configuration Information HP M6710 and 6720 400GB 6G SAS MLC Solid State Devices were added to HP 3PAR SSDs in Configuration Information HP M6710 400GB 6G SAS SFF MLC Encrypted Solid State Device was added to HP 3PAR Encryption SSD/HDD/LTU in Configuration Information HP 622 1075mm Pallet Intelligent Series Rack (22U) was removed from HP Intelligent Series Racks in Configuration

Summary of Changes

			Information
19-jul-2013	From Version 12 to 13	Changed	Superscript was added to the Overview chart.
17-jul-2013	From Version 10 to 12	Changed/Removed	Superscripts were added to the Overview chart. Removed "600GB SAS 10K RPM Hard Disk Drive Encrypted (2.5 in)" from the What's New section.
02-jul-2013	From Version 9 to 10	Changed	Internal Storage for HP 3PAR StoreServ File Controller specifications was revised HP 622 1075mm Pallett Intelligent Series Rack (22U) was removed from HP Intelligent Series Racks
14-jun-2013	From Version 8 to 9	Changed	Changes were made to the Service and Support Section- Note updated
10-jun-2013	From Version 7 to 8	Changed	Changes were made throughout the entire QuickSpec. Added the entire new HP 3PAR StoreServ File Controller section.
13-may-2013	From Version 6 to 7	Changed	Changes were made in the following sections: Configuration Information: Step 5
21-dec-2012	From Version 4 to 5	Changed	Changes were made in the following sections: Configuration: in Step 7 updated part description in Expansion Options.
17-dec-2012	From Version 3 to 4	Changed	Changes were made in the following sections: Service and Support, HP Care Pack and Warranty Information: change made in Related Services section Configuration: change made in Step 8 section.
14-dec-2012	From Version 2 to 3	Changed	Changes were made in the following sections: Overview: in Summary changed text and changed "2013" to "a later release". Service and Support: added hyperlink and ordering information, in Related services added a new service item. Configuration: in Step 1 corrected title, in Step 5 & 7 changed 2013 to a later release, in Step 8 added new software items, in Step 9 deleted the row HP Rack and Rack Options and added HP Virtual Contact information. Added Step 10.
05-dec-2012	From Version 1 to 2	Added	Added the EMEA version.

Summary of Changes

© Copyright 2014 Hewlett-Packard Development Company, L.P.

The information contained herein is subject to change without notice.

The only warranties for HP products and services are set forth in the express warranty statements accompanying such products and services. Nothing herein should be construed as constituting an additional warranty. HP shall not be liable for technical or editorial errors or omissions contained herein.

For drives, 1 TB = 1 trillion bytes. Actual formatted capacity is less.